



396-5149Y1

John Deere DB80 Wing Mounted Tank Kit Mounting Instructions

Planter Manufacturer: **JOHN DEERE**

Kit Number: 530-01-450720

Description: John Deere DB80 Wing Mounted Tanks - 2-200 Gallon

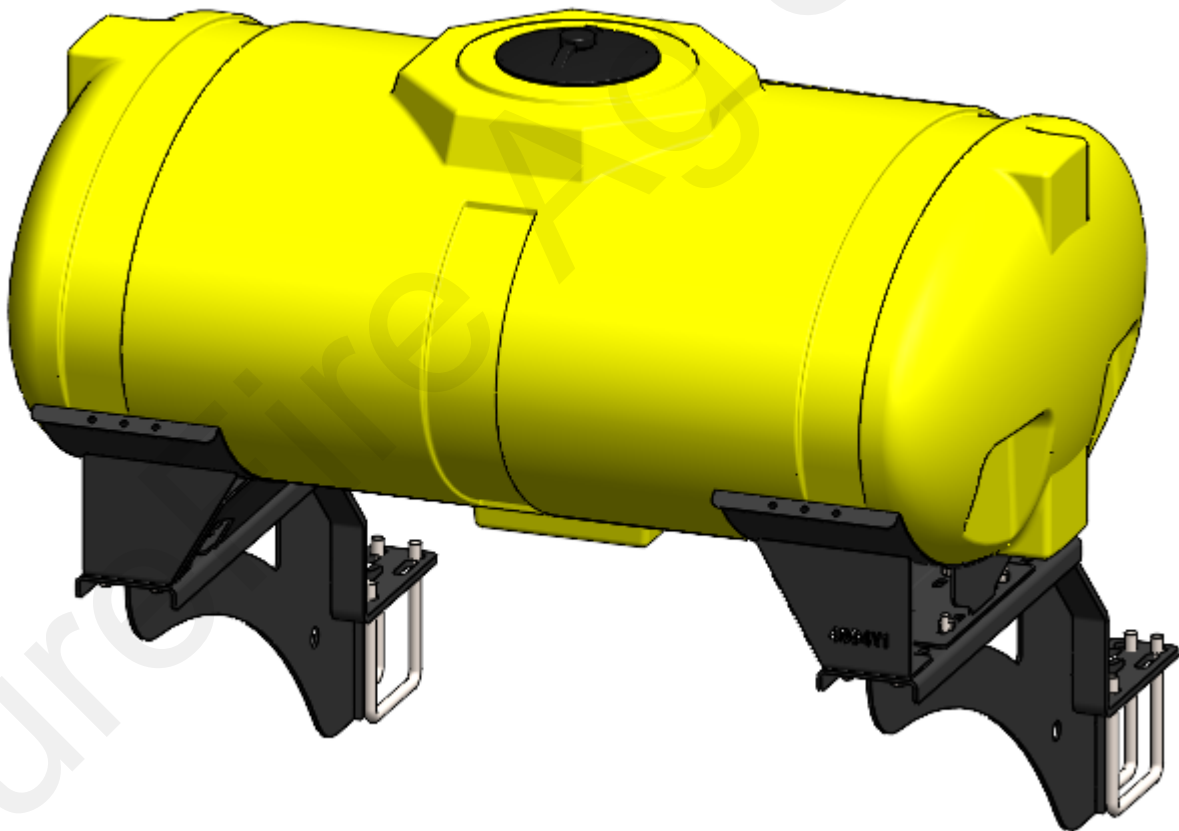



Parts List and Exploded View

ITEM NO.	PART NUMBER	DESCRIPTION	QTY.
1	727-01-HE0200-41-Y	200 Gallon Elliptical Tank - Yellow	2
2	420-4694Y1	200 Gallon Elliptical Tank Saddle	4
3	420-4966Y1	Kinze 16R Wing Mount Tank Bracket	4
4	330-08	1/2" Flat Washer	32
5	300-080108-5	1/2" x 1-1/2" Hex Head Bolt - G5	32
6	323-08	1/2" Flange Nut	32
7	380-1060	3/4" U-bolt Kit - fits 7" x 7" tube	8
8	525-2055	2" Tank Strap Kit	4

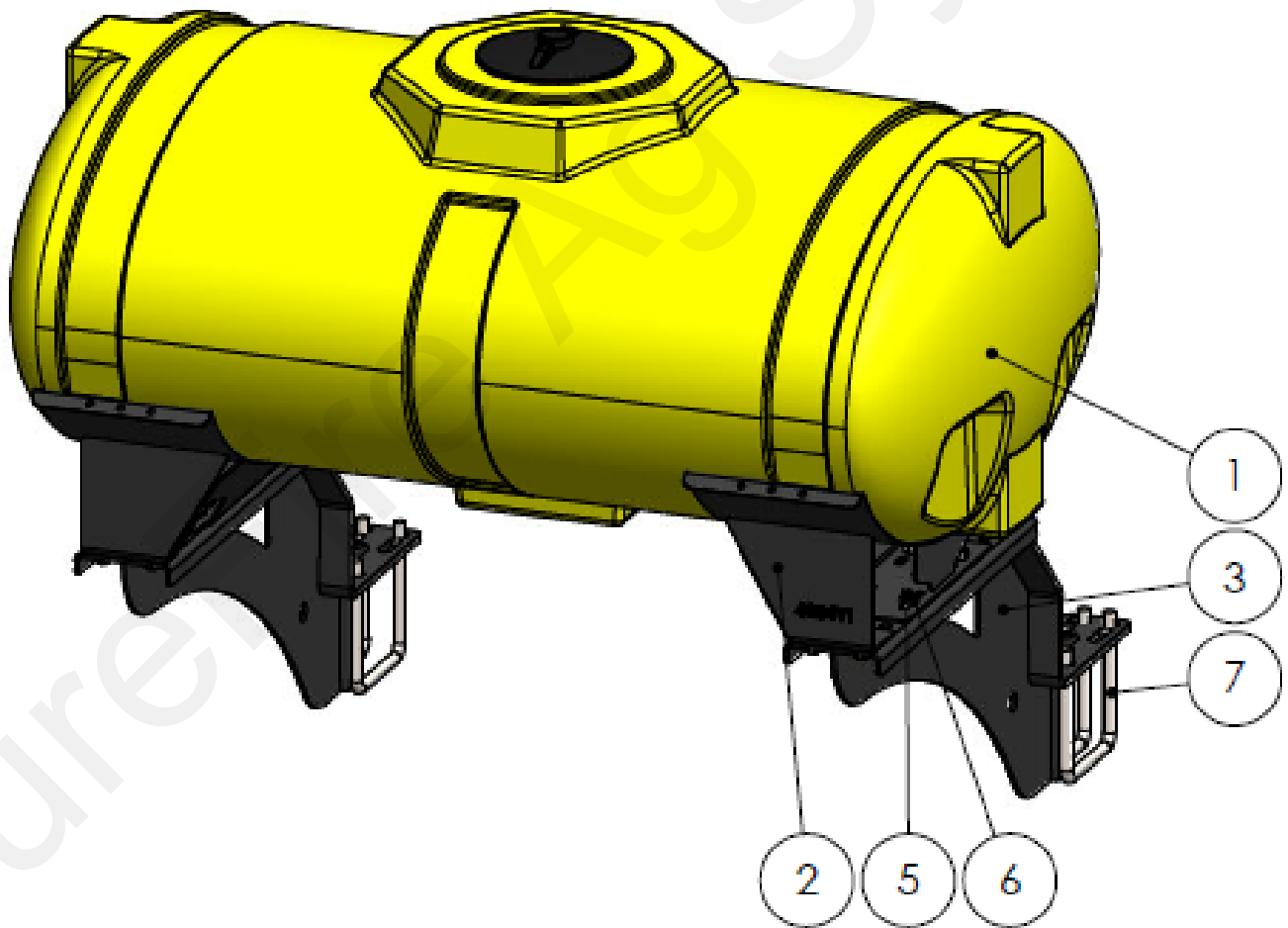

Step by Step Instructions

1. Loosely bolt the 4966Y1 brackets to the 7"x7" wing bar using the provided U-Bolts. Refer to the saddle configurations below when mounting brackets. Place your brackets where they need to be and mount the saddles to the brackets in the configuration that matches.
2. Place the tank saddles on top of the brackets and loosely bolt them on using the provided 1/2" hardware.
3. Place the tank in the saddles. Using the provided tank strap kits, tighten the tank down to the saddles.
4. Tighten all the saddle hardware, followed by the U-Bolts. Before tightening be sure to check your tank for clearance from markers or any obstructions.
5. Tighten the tank straps again after the first filling.

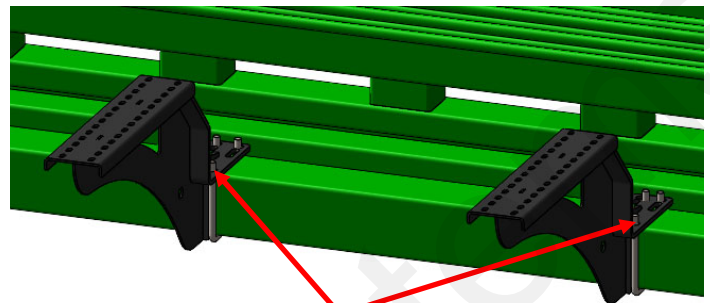

Step 1

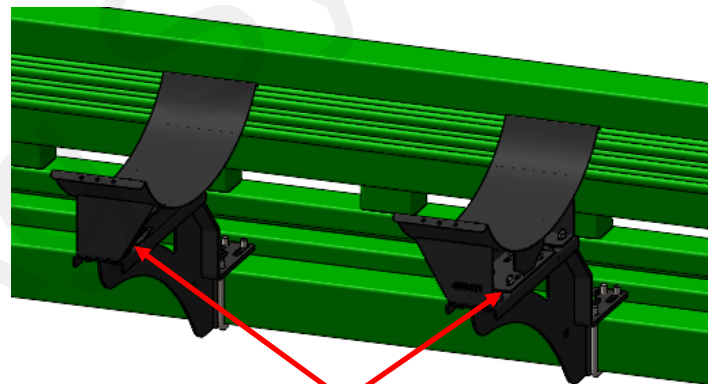

Step 2

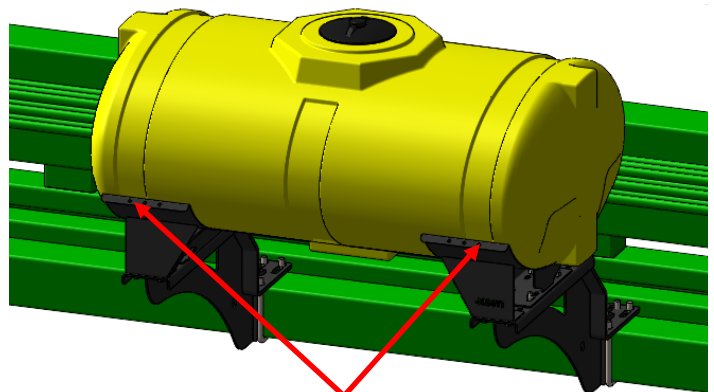

Step 3

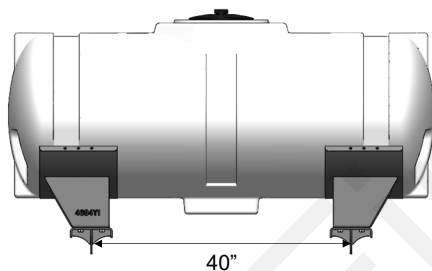

Saddle Configuration # 1

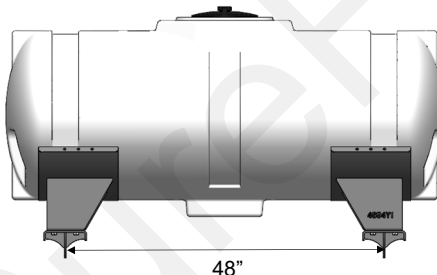

Saddle Configuration # 2

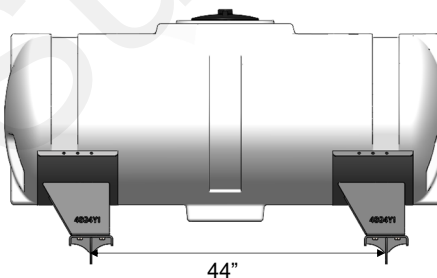

Saddle Configuration # 3