



396-5148Y1

John Deere DB80 Hitch Mounted Tank Kit Mounting Instructions

Planter Manufacturer: **JOHN DEERE**

Kit Number: 530-01-455750 (500 Gallon)

Kit Number: 530-01-455760 (600 Gallon)

Kit Number: 530-01-455775 (750 Gallon)

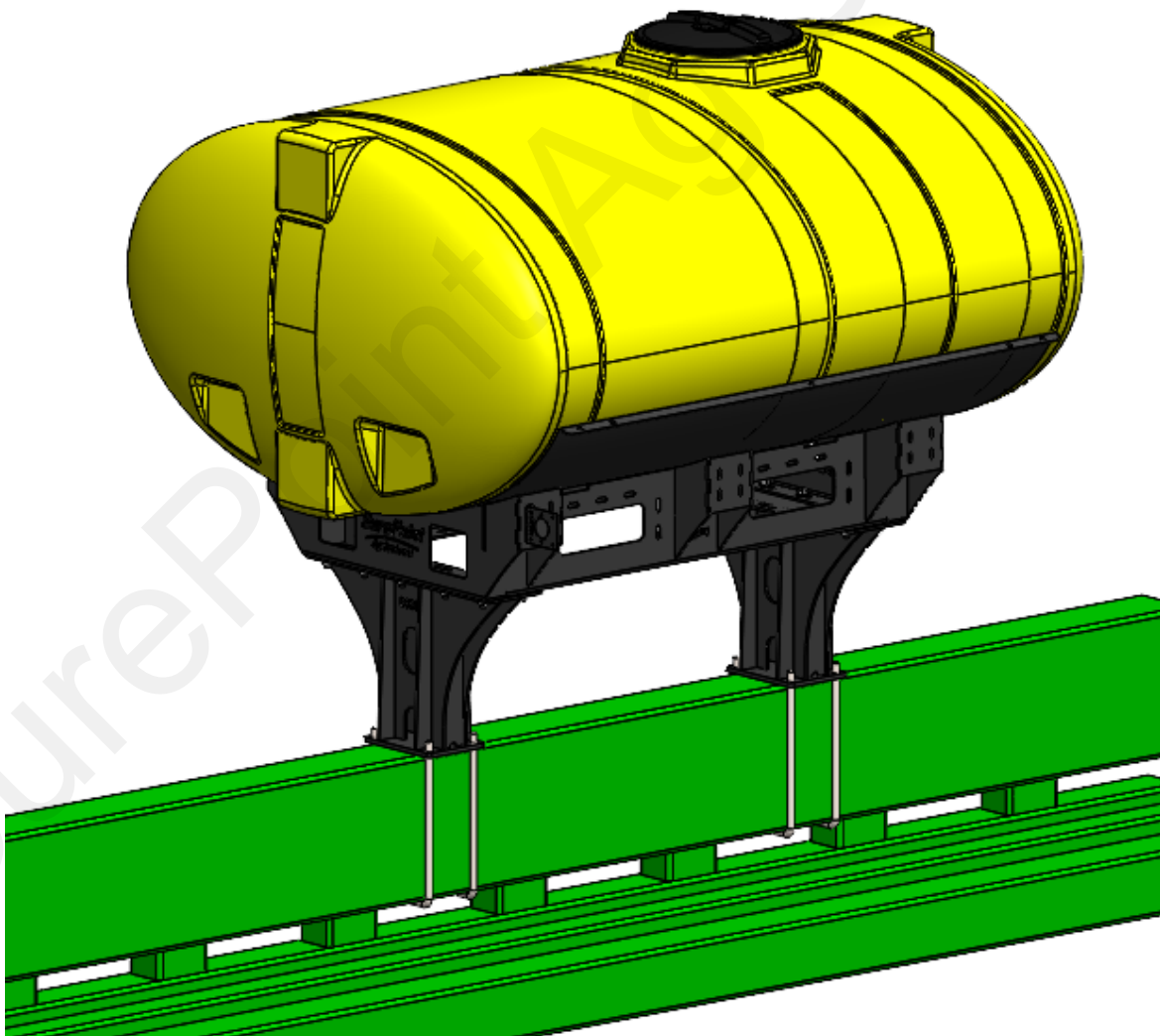



Parts List and Exploded View 530-01-455750

ITEM NO.	PART NUMBER	DESCRIPTION	QTY.
1	727-01-HE0500-57-CS-Y	500 Gallon Elliptical Tank	1
2	421-5638Y1-BK	500 Gallon Elliptical Tank Cradle	1
3	421-5331Y1-BK	18" Tank Pedestal	2
4	307-100108-5	5/8" x 1-1/2" Flange Head Bolt - G5	14
5	300-060012-5	3/8" x 3/4" Hex Head Bolt - G5	2
6	325-10	5/8" Top Lock Flange Nut	14
7	323-06	3/8" Serrated Flange Nut	2
8	380-1067	3/4" U-bolt Kit - fits 8" x 16" tube	4
9	525-3000	Tank Straps, 3" Kit, 400-750 Gallon	3
10	422-2678Y1	Bracket for Vacuum Gauge on JD Planters	1
11	521-01-100255	John Deere CCS Gauge Extension Assembly	1

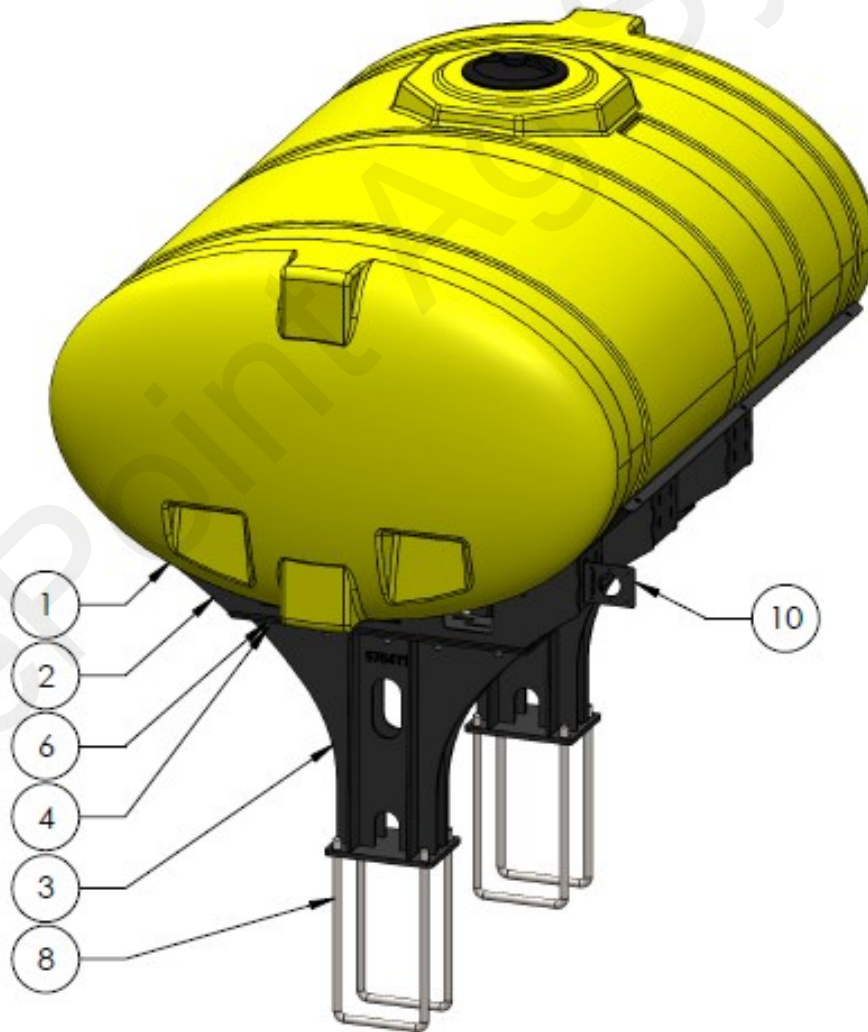



Parts List and Exploded View 530-01-455760

ITEM NO.	PART NUMBER	DESCRIPTION	QTY.
1	727-01-HE0600-64-CS-Y	600 Gallon Elliptical Tank	1
2	421-5321Y1-BK	600/750 Gallon Elliptical Tank Cradle	1
3	421-5331Y1-BK	18" Tank Pedestal	2
4	307-100108-5	5/8" x 1-1/2" Flange Head Bolt - G5	14
5	300-060012-5	3/8" x 3/4" Hex Head Bolt - G5	2
6	325-10	5/8" Top Lock Flange Nut	14
7	323-06	3/8" Serrated Flange Nut	2
8	380-1067	3/4" U-bolt Kit - fits 8" x 16" tube	4
9	525-3000	Tank Straps, 3" Kit, 400-750 Gallon	3
10	422-2678Y1	Bracket for Vacuum Gauge on JD Planters	1
11	521-01-100255	John Deere CCS Gauge Extension Assembly	1

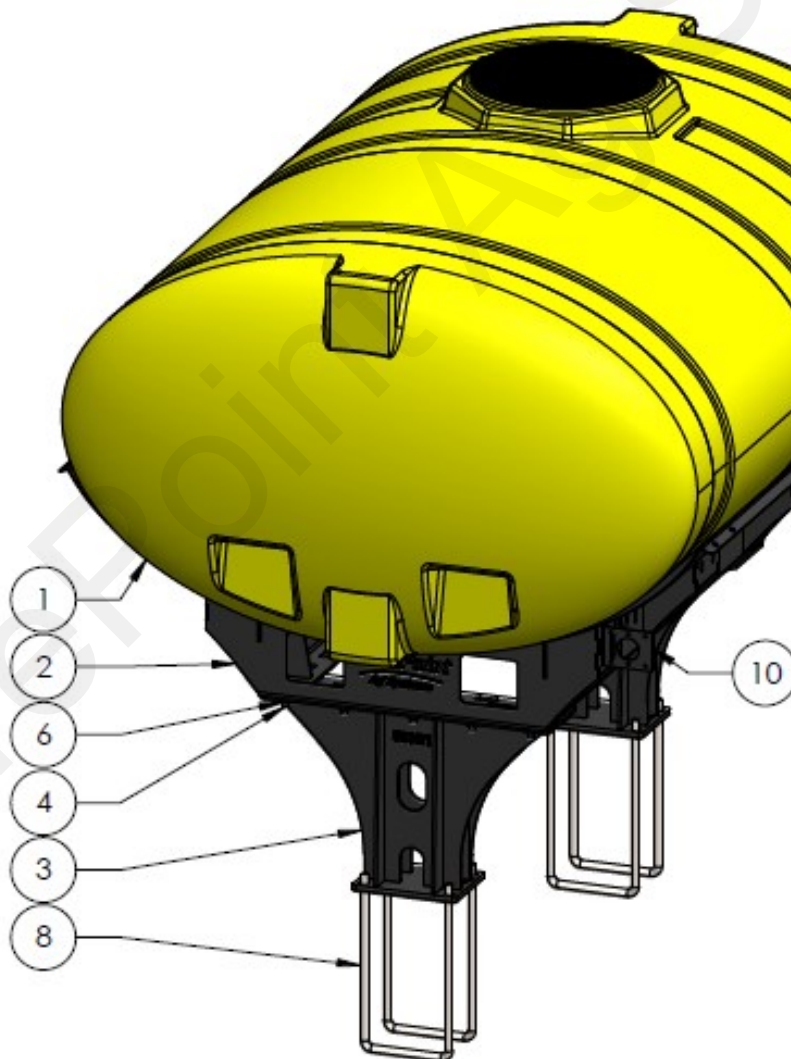



Parts List and Exploded View 530-01-455775

ITEM NO.	PART NUMBER	DESCRIPTION	QTY.
1	727-01-HE0750-69-OS-Y	750 Gallon Elliptical Tank	1
2	421-5321Y1-BK	600/750 Gallon Elliptical Tank Cradle	1
3	421-5331Y1-BK	18" Tank Pedestal	2
4	307-100108-5	5/8" x 1-1/2" Flange Head Bolt - G5	14
5	300-060012-5	3/8" x 3/4" Hex Head Bolt - G5	2
6	325-10	5/8" Top Lock Flange Nut	14
7	323-06	3/8" Serrated Flange Nut	2
8	380-1067	3/4" U-bolt Kit - fits 8" x 16" tube	4
9	525-3000	Tank Straps, 3" Kit, 400-750 Gallon	3
10	422-2678Y1	Bracket for Vacuum Gauge on JD Planters	1
11	521-01-100255	John Deere CCS Gauge Extension Assembly	1

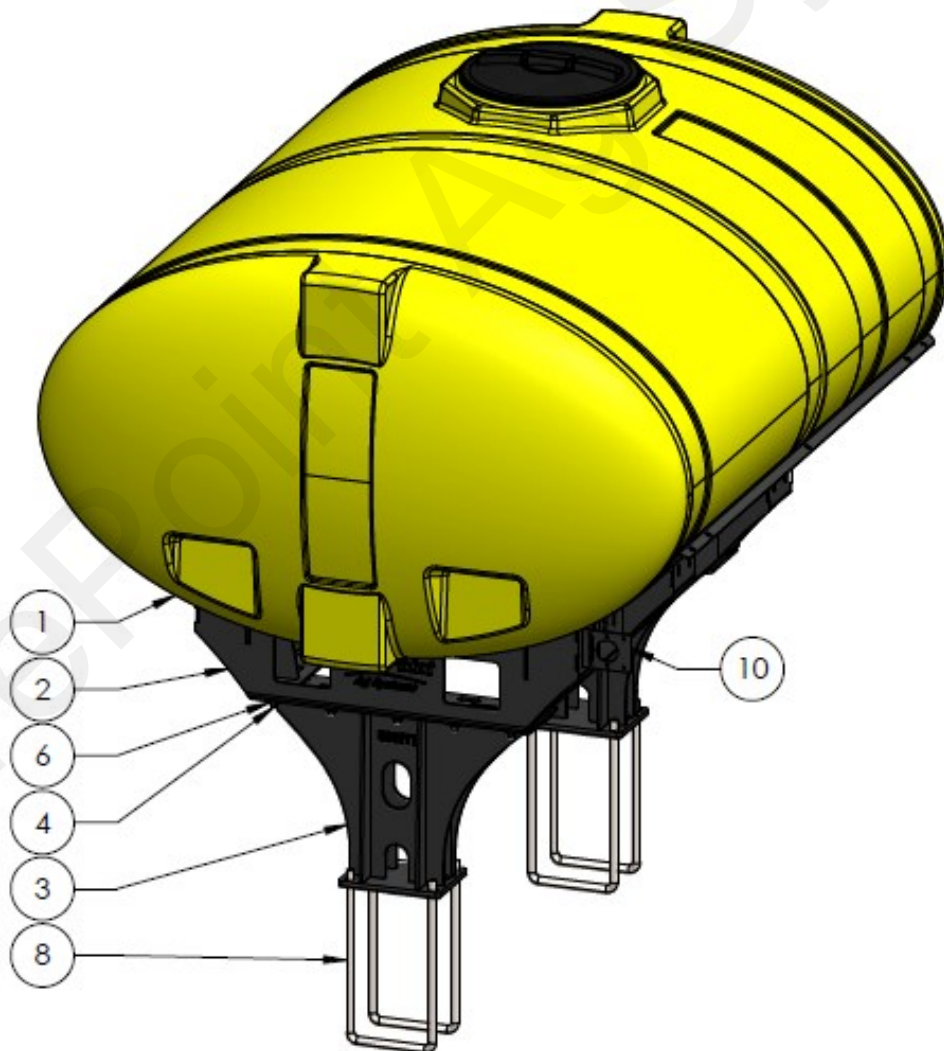



Step by Step Instructions

1. Place the pedestals on the main hitch bar. Loosely bolt the pedestals to the hitch using the provided U-Bolts.
2. Place the tank cradle on top of the pedestals and loosely bolt them together using the provided 5/8" hardware.
3. Place the tank in the cradle, line the tank strap grooves up with the hole pattern in the cradle. Using the provided tank strap kits, tighten the tank down to the cradle. Be sure that tank has proper clearance from all obstructions towards the rear of the planter (CCS tanks, CCS fan).
4. Tighten down the 5/8" cradle hardware, followed by the U-Bolts. Be sure to get them as tight as possible.
5. Tighten the tank straps once more after the first filling.
6. Vacuum gauge extension bracket, see optional instructions on page 6.

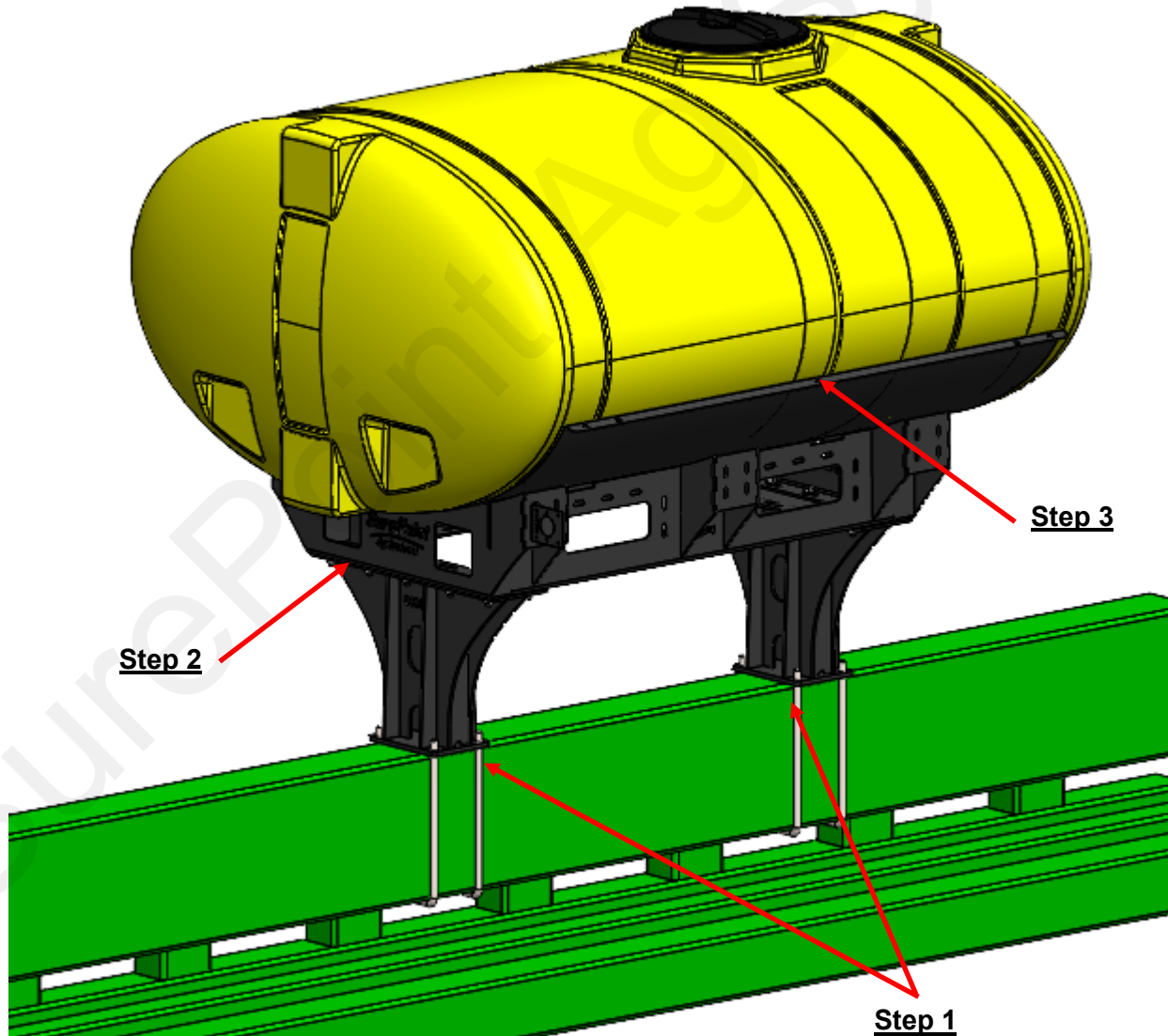



Optional Vacuum Gauge Bracket Installation Instructions

The CCS vacuum gauge must be moved so it can be seen with the tank installed.

Instructions:

1. Remove gauge from current mount (easiest before tank is installed)
2. Mount 422-2678Y1 gauge bracket to tank cradle using 3/8" bolts and flange nuts.
3. Extend vacuum hose to new gauge location using 1/4" hose mender and 3/8" OD poly tubing, Part Number 521-00-100255.
4. Mount vacuum gauge to new bracket using existing hardware.

