



396-4815Y1

QuickDraw ChemBlade® Stainless Steel Inductor Tank Manual

CHEM-BLADE®





Safety Instructions

DUE TO RISK OF SEVERE PERSONAL INJURY, DO NOT INSTALL THIS EQUIPMENT UNTIL YOU HAVE COMPLETELY READ AND FULLY UNDERSTAND HOW TO FOLLOW ALL OF THESE WARNINGS AND INSTRUCTIONS.

WARNING

 Sharp point and blades pose a risk of puncture and laceration. Use gloves and extreme caution when positioning hands and arms to avoid coming in contact with the Chem-blade. Make sure footing is stable and balanced before operation.

 To avoid the risk of severe injury, including laceration and puncture wound, never reach into the tank to retrieve any object or contaminate without first safely removing the Chem-blade.

 Do not use with smaller jugs than 2.5 gallon and use extreme caution with smaller containers to avoid hands and arms coming in contact with sharp Chem-blade point and blades.

 High pressure water used with chemicals poses a risk of splash with chemical residue. Always wear safety glasses to reduce the risk that water and chemical could come in contact with your eyes.

 Always use all personal protective equipment specified by the chemical manufacturer or supplier which may include but not be limited to chemical protective gloves, eye protection, protective footwear and clothing, and niosh approved respiratory protection.

 Always position the handle and lid opening of the chemical container in the vertical and upright position when operating the Chem-blade in order to be able to have a firm grip on the container.

 Slowly open rinse supply valve to make sure only enough water pressure is applied and not to over pressure. Too much water pressure could cause you to lose grip on the chemical container, splash chemical or cause the rinse head to fail. Only partial opening of the rinse valve may be necessary.

 Never operate the rinse head with the tank lid open and without the liquid chemical container positioned over the rinse head to avoid spray of water or chemical out of the tank.



Plumbing Instructions

Installation with QuickDraw^{Max} 3000:

Eductor system kits must be plumbed to the outlet/discharge side of the transfer pump for proper venturi operation. Installation location on sprayer tender trailer may vary.

1. Remove cap and connect 200 Series flange x 1-1/2" hose barb fitting to the "Eductor Suction" port in the side of the QuickDraw 3000.
2. Route 1-1/2" hose from the "Eductor Suction" port to the outlet of the inductor tank Venturi.
3. Connect 2" female cam lever fitting x 1-1/2" hose barb to the "Eductor Supply" valve on the QuickDraw 3000.
4. Route 1-1/2" hose from the "Eductor Supply" port to the inlet of the inductor tank Venturi.

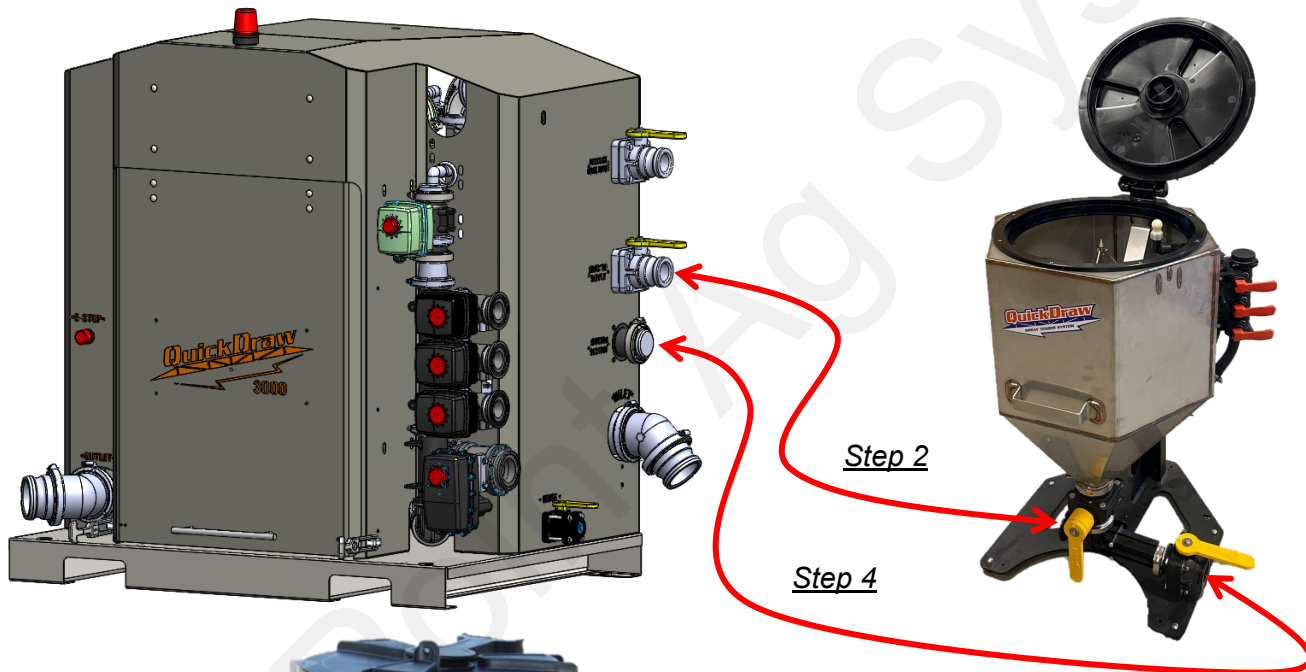
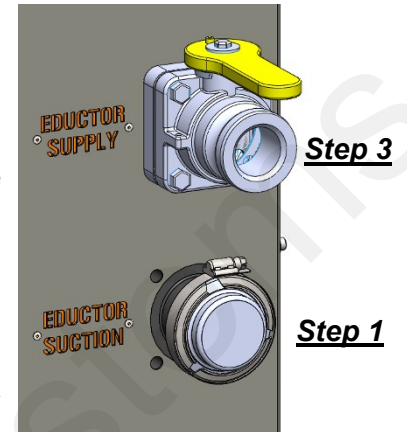

3" Bypass System Kit Installation:

Eductor system kits must be plumbed to the outlet/discharge side of the transfer pump for proper venturi operation. Installation location on sprayer tender trailer may vary.

1. Connect 3" inlet port to the discharge side of the QuickDraw or transfer pump. Preferred installation location is downstream of the QuickDraw.
2. Connect 3" outlet port of inductor to the sprayer.

To Sprayer

From Transfer Pump



No Bypass Kit Operation Instructions

FULL Chemical Jug Operation:

This process is typically executed during the "Manually Add Product" cycle on QuickDraw^{MAX} or at any time during loading with QuickDraw^{LITE}.

1. Firmly grab liquid chemical container and suspend directly over the tip of the blade. With speed, press container down onto ChemBlade until the container is halfway down the blades or until sufficient puncture has occurred so contents can empty. Use care not to push to far to avoid hands and arms coming in contact with the sharp point and blade.
2. Close the lid and open the Blade Rinse Valve and water will flow through the rotary rinse head at the center of the blade to thoroughly rinse the inside of the jug.
3. Open Water Supply Valve and Tank Valve to pull product from the tank, through the venturi valve and into the QuickDraw or batch. *Note: Open the Water Supply Valve first to start flow through the venturi and begin to pull a suction before opening Tank Valve.*
4. With the Tank Valve open, close rinse valves, then close the tank lid and open Blade Rinse Valve and Dry Flush Valve to clean the tank. After tank is evacuated, close all valves.
5. Discard chemical jug properly and resume QuickDraw operation.

EMPTY Chemical Jug Operation:

1. Turn the jug upside down over the white ball rinse nozzle. Open the middle red handled Jug Rinse Valve to rinse the empty jug.
2. Close middle Jug Rinse Valve and discard chemical jug properly.

DRY Product Operation:

1. Unlike a chemical jug, a bag of dry product is not likely to need rinsed. Drop the bag(s) onto the ChemBlade and shake remaining contents into the tank.
2. Close the tank lid and open Dry Flush Valve and Blade Rinse Valves to create a slurry of the dry product and water, to ease transport through the venturi valve. *Note: Slurry valve can be opened prior to Step 1.*
3. Open 2" Water Supply Valve and Tank Valve to pull product from the tank, through the venturi valve and into the QuickDraw.
4. After tank is evacuated, close rinse valves and tank valves.

Note: All water used for rinsing and mixing is still being measured

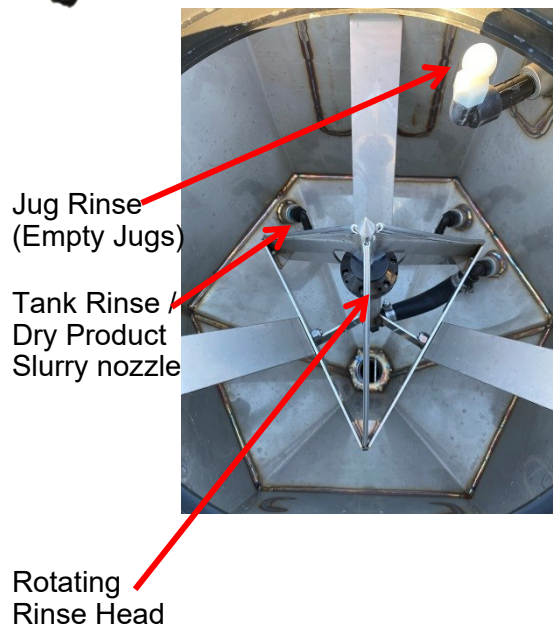



3" Bypass Kit Operation Instructions



JUG RINSE
DRY FLUSH
BLADE RINSE

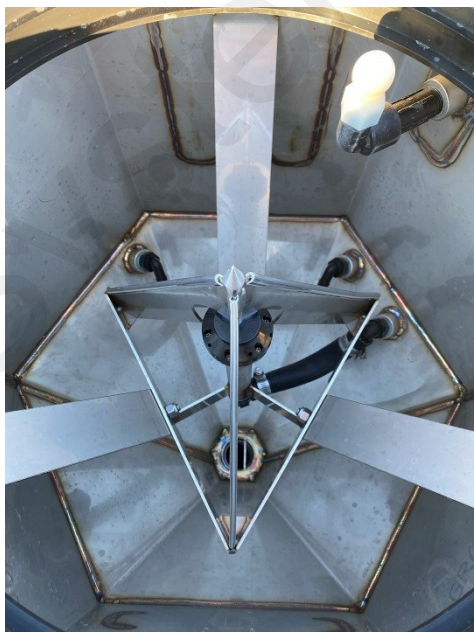

FULL Chemical Jug Operation:

This process is typically executed during the "Manual Add Product" Cycle on QuickDraw^{MAX} or at any time during loading with QuickDraw^{LITE}.

1. Firmly grab liquid chemical container and suspend directly over the tip of the blade. With speed, press container down onto ChemBlade until the container is halfway down the blades or until sufficient puncture has occurred so contents can empty. Use care not to push too far to avoid hands and arms coming in contact with the sharp point and blade.
2. Close the lid and open the Blade Rinse and water will flow through the rotary rinse head at the center of the blade to thoroughly rinse the inside of the jug.
3. Close 3" Bypass Valve and open Tank Valve to pull product from the tank, through the venturi valve and into the QuickDraw or batch.
4. With the Tank Valve open, close rinse valves, then close the tank lid and open Blade Rinse Valve and Dry Flush Valve to clean the tank. After tank is evacuated, close all valves, and re-open 3" Bypass Valve to top off sprayer.
5. Discard chemical jug properly and resume QuickDraw operation.

EMPTY Chemical Jug Operation:

1. Turn the jug upside down over the white ball rinse nozzle. Open the top red handled Jug Rinse Valve to rinse the empty jug.
2. Close middle Jug Rinse Valve and discard chemical jug properly.

DRY Product Operation:

1. Unlike a chemical jug, a bag of dry product is not likely to need rinsed. Drop the bag(s) onto the ChemBlade and shake remaining contents into the tank.
2. Close the tank lid and open Blade Rinse Valve and Jug Rinse Valves to create a slurry of the dry product and water, to ease transport through the venturi valve.
3. Close 3" Bypass Valve and open Tank Valve to pull product from the tank, through the venturi valve and into the QuickDraw.
4. After tank is evacuated, close rinse valves and tank valves.

Note: All water used for rinsing and mixing is still being measured by the QuickDraw automated spray tender system.

Replacement Parts List

ITEM NO.	PART NUMBER	DESCRIPTION
1	102-01-220VHE	Stubby Valve Handle Extension
2	102-220MVSCF	2" Manifold Stubby Full Port Poly Valve
3	102-V463T053	3-Port Manifold Valve (includes HB fittings)
4	105-220-3371-0038	2" Full Port Manifold Venturi, 11mm Nozzle, RH
5	120-T5FCAP	T5 Female Cap
6	120-T5M100	T5 Male FC x 1" HB
7	385-VSM44	1/2" Nylon Ball Rinse Nozzle (White Ball)
8	385-55270	3/4" Rotating Jug Rinse Nozzle (Black Nozzle on Blade)
9	398-30-4878Y1	ChemBlade 20 Gallon Eductor Valve Handle Decal - Jug Rinse
10	398-30-4879Y1	ChemBlade 20 Gallon Eductor Valve Handle Decal - Dry Flush
11	398-30-4880Y1	ChemBlade 20 Gallon Eductor Valve Handle Decal - Blade Rinse
12	480-4805Y1	20 Gal Stainless Steel Tank - With Chemblade
	480-4806Y1	20 Gal Stainless Steel Tank - No Chemblade
13	727-31-TL160016	Hypro 16" Hinged Lid
14	757-92375A100	Cotter Pin, Hairpin, 316 Stainless Steel
15	757-9433K430	Extension Spring, Hook Ends, 302 Stainless Steel
16	475-4087Y1-BK	Parallel Arm Latch Weldment - QuickDraw Swing Down Eductor
17	359-5889Y1	Gas Spring, 28" Cylinder Only, 125 lb.
18	359-5890Y1	Ball Socket, M8 x 1.25 thread, M13 socket
19	359-5891Y1	Ball Stud, 5/16" x 1" thread, M13 ball joint
20	396-5888Y1	QuickDraw Swing Down Gas Spring Retrofit Instructions
21	120-T3M050	T3 Male FC x 1/2" HB

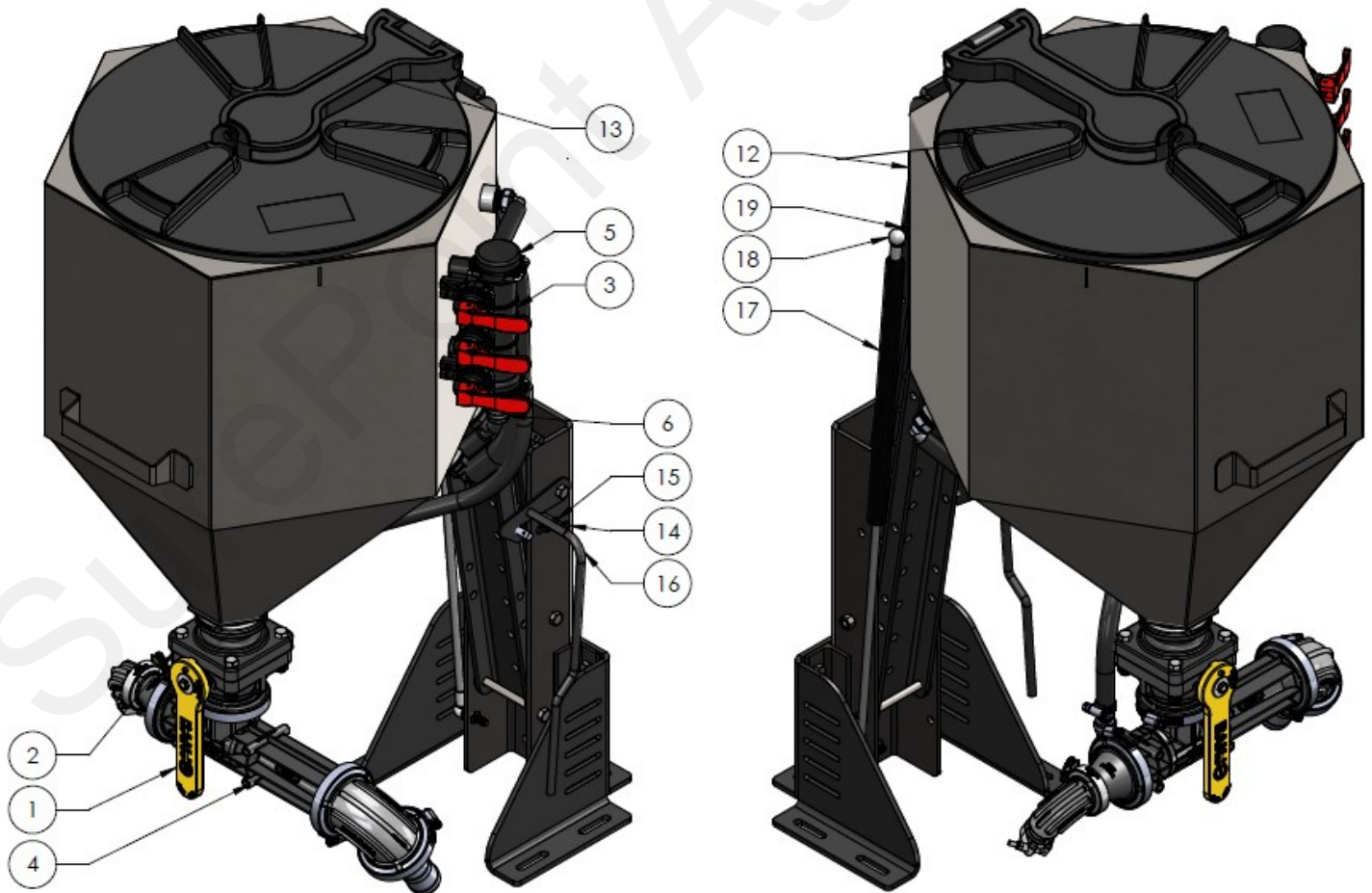

Steps of Operation



TO AVOID SERIOUS PERSONAL INJURY, BE SURE TO READ, UNDERSTAND AND FOLLOW ALL SAFETY INSTRUCTIONS LISTED ABOVE AND ALL STEPS LISTED BELOW.

1. Firmly grab liquid chemical jug with one hand on the handle and one hand on the lid of the jug; for bags of dry product firmly hold two corners of the bag with two hands.
2. Suspend jug or bag centered vertically straight up from the tip of the Chem-Blade.
3. With speed, press container down onto Chem-Blade until container is half way down blades or until sufficient puncture has occurred so contents can empty. Use care not to push too far to avoid hands and arms coming in contact with the sharp point and edges of the Chem-Blade.
4. Once liquid chemical has emptied from the container, while keeping firm hold of the container, open rinse supply valve slowly and introduce only enough water pressure to apply rinse. **Do not use rinse for dry product application.**
5. After running the rinse system for the time specified by the chemical manufacturer or supplier, turn off rinse supply valve and allow container to drain completely as directed by the chemical manufacturer or supplier.
6. Pull straight up on container and remove it from the Chem-Blade and discard as directed by the chemical manufacturer or supplier.
7. For less than full containers, empty the contents into the inductor tank then hold the jug upside down over the white jug rinse ball nozzle and open the supply valve to clean the jug per the chemical manufacturer or supplier directions.
8. Successful Operation!

Troubleshooting

- **Recommended operating pressure for rinsing system 10–50 PSI (0.7–3.5 bar).**
- If Rinse Head does NOT rotate and rinse the containers/tank properly it is suggested to run a small in-line 80 Mesh strainer on the rinse head supply line. The rinse head utilizes tight tolerances for performance, dirty or contaminated rinse supply will cause clogging. This clogging will not hinder the pressurized spray from the head but will stop it from rotating.
- In case of the rinse head halting rotation, simply remove blade assembly from frame, remove single screw from top of rinse head, wipe clean, and reassemble.
- If tank is being converted from 12 inch lid to 16 inch lid make sure the fitment of Chem-Blade to tank is tight but not too tight where lid collar is buckled and lid will not thread on properly. Lid collar can have some height variance where Chem-Blade attaches but excessive buckling will cause improper lid operation. To cure this, the proper diameter of lid opening needs to be cut. Use new tank lid collar to trace outline cut. Trim tank cautiously going from smaller diameter to larger. Set tank lid into brim before Chem-Blade to check proper fit diameter. The lid by itself will fit loosely. Allow approximately an 1/8" gap the entire circumference for the Chem-Blade legs to fit.



SurePoint Ag Systems