



**SurePoint**  
Ag Systems

**396-4519Y1**

**SENTINEL NH<sub>3</sub>**  
ANHYDROUS ROW MONITOR

# Sentinel NH3 Blockage Monitor for ISOBUS

## Installation and Setup

The screenshot displays the following interface elements:

- Top Left:** "Prod # 1 Row # 13" and "DEG F 72.00".
- Top Center:** "SENTINEL" logo and "1-N".
- Top Right:** "A" SurePoint Ag Systems logo and "E" SENTINEL sensor status indicators.
- Middle Left:** "AVERAGE TEMP 72.1 DEG F".
- Middle Center:** "MASTER ON" button.
- Middle Right:** "SPEED 6.0 MPH" and a settings gear icon.
- Bottom Left:** A grid of 16 columns labeled 1-16, representing individual rows.
- Bottom Right:** "G", "H", "I" status indicators, a "J" maintenance icon (wrench and screwdriver), and a status bar showing "MAW" and "2:11pm".
- Bottom Center:** A legend with three boxes: a green box for "ROW ON/OK", a grey box for "ROW OFF", and a red box for "FLOW COM ALARM".
- Bottom Far Right:** "Page 0", a home icon with "2/2", and a navigation icon.

SurePoint Ag Systems



# Table Of Contents

## Introduction

- Anhydrous Ammonia Safety and General Information..... 1-5
- Basic Steps to Install your Sentinel System ..... 6-7



## Components - Wiring & Electrical

- Harness Layout..... 8
- Component List..... 9
- Component Layout ..... 9-11
- Y Harness and Terminator Installation ..... 12
- Harness Drawings ..... 13-17
- Temperature Interface Module and Temperature Sensor..... 18

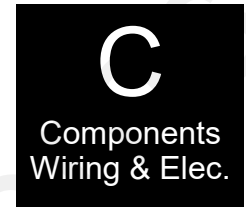

## Setup & Operation

- Basic Steps for Initial Setup ..... 19
- Home Screen Navigation & Buttons..... 20
- Settings ..... 21
- Product Setup..... 21-22
- Implement Setup..... 22
- Speed Input ..... 23
- Hardware Setup (Master Switch, Lift Switch, Task Control, IntelliSection) ..... 23
- Alarm Setup..... 24
- Module Addressing ..... 24
- Rate Setup..... 25
- Sentinel Operation (Home Screen, Alarm Screen, Row Detail)..... 26
- Sentinel Software Information ..... 27



## Troubleshooting

- Flow module addressing issues, No Flow Showing, Rows are Grey ..... 28
- Sentinel shows row reading too high or too low ..... 28
- Sentinel Alarms too often ..... 28
- Sentinel doesn't display speed..... 29



## Care & Maintenance

- Cleaning ..... 30
- Winterization..... 30
- Pre-season Service ..... 30



## Sentinel Accessories

- Mounting Brackets ..... 31
- ISO Extensions ..... 31
- Height Switches ..... 31
- GPS Speed Receiver..... 31
- 3-Pin WP Extensions, Dust Caps..... 32



**ATTENTION:** Please follow all of the instructions in this manual carefully and read the entire manual completely. Failure to do so may cause the product to function improperly or fail causing serious injury or death.



**DANGER**

**DANGER**

**ANHYDROUS AMMONIA IS AN INHALATION HAZARD AND WILL CAUSE SERIOUS INJURY OR DEATH. PLEASE USE EXTREME CAUTION WHEN HANDLING IT OR PERFORMING ANY MAINTENANCE ON EQUIPMENT USED FOR ANHYDROUS AMMONIA.**

**ATTENTION:** Before performing any installation, repair or maintenance please follow the instructions below.

1. You must be trained and certified to work with anhydrous ammonia. If you are not, please seek out the appropriate agricultural department to attend a class to obtain the proper training and certification.
2. Wear appropriate safety goggles, gloves and breathing apparatuses.
3. Always know which way the wind is blowing.
4. Drain all tanks, hoses and piping of anhydrous ammonia COMPLETELY before removing, installing, performing maintenance or repairing any equipment.
5. Always remove device from service before performing any maintenance or repair.
6. Have sufficient water nearby.
7. Obey all local, state and federal laws regarding the handling of anhydrous ammonia.

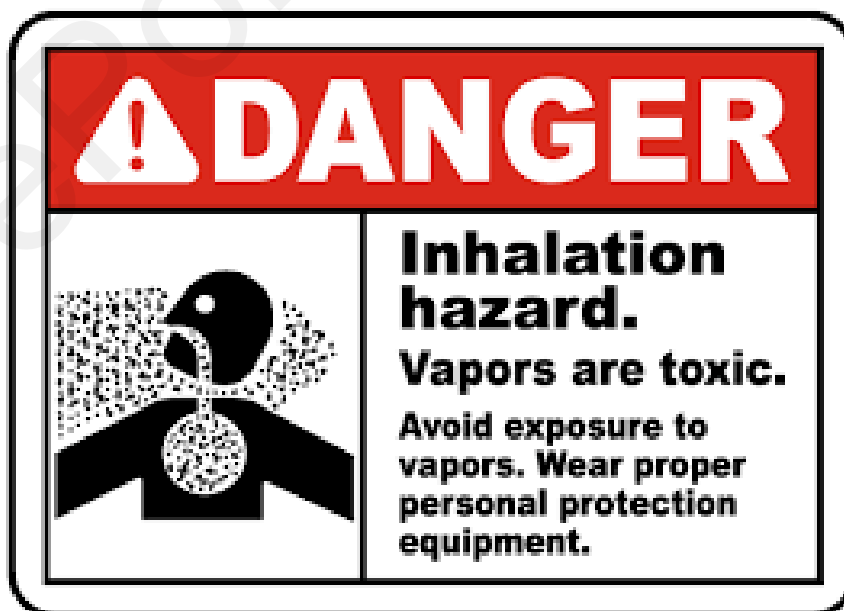



## Anhydrous Ammonia Safety

Anhydrous ammonia is an important source of nitrogen fertilizer for crops. The improper handling of anhydrous ammonia can have catastrophic results on both plants and farm workers. Common injuries are severe burns to eyes, skin and the respiratory tract.

- Personal protective equipment (PPE) should always be worn. Standard PPE should be non-vented goggles, rubber gloves with thermal lining, face shield or an approved respirator. Wear a lightweight rubber suit, or (at the very least) a long sleeve shirt and coveralls.
- Make sure anhydrous ammonia tanks are not filled beyond the recommended capacity.
- Use care when handling the hose end valve so that it does not open accidentally. Do not move the hose by handling valve handle.
- Be sure to bleed the hose coupling before disconnecting. Use care when cleaning plugged knives as anhydrous ammonia could be built up behind the plug.
- Use emergency water supply for at least 15 minutes if exposed to anhydrous ammonia and then seek emergency medical attention.
- Always have a small squeeze bottle of fresh water at all times.
- Never assume NH<sub>3</sub> lines are empty, including the lines connected to the NH<sub>3</sub> cooler.
- Make sure the system is completely drained of NH<sub>3</sub>. It can hide in low areas of the system. Look for frost on the hose or equipment. That usually means there is NH<sub>3</sub> there.
- Always use high pressure hose when ammonia can be trapped in that segment, such as between the tank and the NH<sub>3</sub> cooler.
- Any place that has a high pressure hose should also have a hydrostatic relief valve and a bleed valve.
- Always handle valves by the body and not by the wheel or latch.
- Always make sure you are upwind of potential NH<sub>3</sub> release points.
- When you park, position NH<sub>3</sub> equipment downwind from dwellings, people, and livestock.
- Close the valve on the tank when you stop.
- The first treatment for anhydrous ammonia exposure is WATER.

***NH<sub>3</sub> is a very dangerous product. It can kill you or blind you or worse. If you have not taken an approved NH<sub>3</sub> Safety class, do not work around NH<sub>3</sub>. If you have had the course, follow ALL safety precautions ALL the time.***

# BE CAREFUL !

Before you start applying NH<sub>3</sub>—

- Know the wind direction.
- Are the hoses in good condition?
- Has the expiration date been passed on any hose or other dated component?
- Are all fittings clean and free from rust?
- Do low-pressure tubes have any leaks?
- Are any knives plugged?
- Is the pressure relief valve operating correctly?
- Does the tank have five gallons of fresh water?
- Is PPE available and being worn (goggles, gloves, long-sleeve shirt) ?

Before performing maintenance on the toolbar or equipment—

- Put on gloves and goggles
- Make sure you have emergency water
- Check wind direction and stay upwind
- Park away from buildings, livestock, and people
- Before servicing, close the valve on the NH<sub>3</sub> tank and continue application to bleed the system.
- Be sure the tank valve is closed. Turn the Master valve on and leave it on during bleeding.
- Disconnect the nurse tank supply hoses.
- Open all bleeder valves on cooler and rest of system.
- Check any hoses that have a low loop in them
- Even after bleeding, slowly and cautiously loosen any fittings to be sure there is no ammonia trapped inside.



# Things to Know About Anhydrous Ammonia (NH<sub>3</sub>)

Anhydrous ammonia is a colorless non-flammable liquefied gas. Its vapor is lighter than air and has the same pungent odor as household ammonia. Although ammonia vapor is lighter than air, the vapors from a leak may hug the ground appearing as a white cloud. Chemically, ammonia is 82% nitrogen (N) and 18% hydrogen (H) and has the chemical formula NH<sub>3</sub>. Ammonia by weight is 14 parts nitrogen to 3 parts hydrogen, or approximately 82% nitrogen and 18% hydrogen.

The definition of *anhydrous* is *without water*. Whereas household ammonia is 95% water, anhydrous ammonia has no water. Ammonia is so hydroscopic (water loving) that one cubic foot of water will dissolve 1300 cubic feet of ammonia vapor making water the primary weapon for first responders.

Ammonia weighs 5.15 pounds per gallon (0,63 kg/L) in contrast to water which weighs 8.33 pounds per gallon (1,0 kg/L). Since ammonia is so soluble in water there will be no layering effect when liquid ammonia is spilled into a surface water body. Booms, pads, sweeps and pillows that are usually used to contain and recover petroleum are ineffective on spills of ammonia into surface water.

Ammonia is a non-flammable gas but will ignite at a temperature of 1204°F within vapor concentration limits between 15% and 28%. (Paper ignites at 450°F, coal at 750°F.) Outside conditions that would support these vapor concentrations are very rare.

Ammonia will corrode galvanized metals, cast iron, copper, brass, or copper alloys. All ammonia piping, valves, tanks and fittings are constructed of steel.

Liquid ammonia boils at any temperature greater than -28°F (-33° C) and will expand to 850 times its liquid volume. One gallon of liquid will expand to 850 gallons or 113 cubic feet of gas.

## Ammonia Fast Facts

### NH<sub>3</sub> Vapor

Ammonia appears in nature as a natural substance that results from decomposition.

Ammonia vapor is a colorless gas with a pungent odor.

Ammonia exists as a vapor at atmospheric conditions.

Ammonia vapor is lighter than air and tends to rise when released to atmosphere.

### NH<sub>3</sub> Liquid

Liquid ammonia released to atmosphere forms a white smoke by freezing the moisture in the air.

Liquid ammonia has a very high coefficient of expansion with temperature.

One gallon of liquid ammonia weighs approximately 5.15 lbs.; however the weight varies with temperature.

A closed container of liquid ammonia is in equilibrium with ammonia vapor and the container pressure bears a definite relationship to the temperature.

### Physical Data

Boiling point is -28°F (-33° C).

Ignition point is 1,204°F (651°C).

## Storage and Handling

Ammonia is stored and transported as a liquid under pressure.

The pressure on the tank is the liquid pressure and remains the same whether the tank is 10% full or 80% full. **This pressure is dependent on the temperature of the NH<sub>3</sub>.**

The maximum filling level of an anhydrous ammonia tank is 85%.

## Flammability

Anhydrous ammonia is classified by the DOT as a non-flammable gas.

Ammonia vapor is flammable over a narrow range of 15% to 28% by volume in air and a strong ignition source must be present.

## Anhydrous Ammonia Application

Precision application of anhydrous ammonia starts with a proper metering system. It is crucial to be sure the metering and control system is applying what is required.

Accurate metering of anhydrous ammonia is difficult to achieve with a conventional variable orifice meter. Anhydrous ammonia is stored and transported as a liquid. To maintain NH<sub>3</sub> as a liquid it must be kept below -28°F (-33°C) or maintained under pressure. If the temperature of the NH<sub>3</sub> increases above -28°F (-33°C) some of the liquid changes to a gas as the NH<sub>3</sub> begins to boil. Application equipment typically uses tank pressure to deliver NH<sub>3</sub> to the soil. An increase in tank pressure would tend to force more NH<sub>3</sub> through the distribution lines. The actual pounds of NH<sub>3</sub> being applied decreases or increases as tank pressure fluctuates unless continuous adjustments are made to the meter.

If NH<sub>3</sub> is released into the atmosphere it will expand rapidly to occupy a volume 850 times greater than the original liquid. NH<sub>3</sub> readily changes from liquid to gas in the nurse tank and distribution system. Consequently the ratio of NH<sub>3</sub> gas to liquid continually changes as it passes through the distribution lines. About 1% of the liquid will vaporize during the ammonia flow from the tank dip tube to the metering point. 1% liquid when expanded to vapor at 100 lb tank pressure will occupy approximately 25% to 30% of the delivery chamber. At 50 lb tank pressure this increases to over 60% of the delivery chamber occupied by vapor. This makes metering and distributing NH<sub>3</sub> very difficult to do consistently and accurately.

For high volume application, wide implements, fast speeds and cold temperatures the *delivery component pieces are critical for delivering the flow needed*. A flow that can be delivered at 90° may not be achievable when the temperature drops to 40° if the system components are not designed and sized correctly. These pieces include: **Tank withdrawal valve, NH<sub>3</sub> delivery hose and breakaway coupler, and heat exchanger with adequate capacity.**

After this precise metering the *challenge of row distribution* still awaits. The proper **manifold system** is important for row to row accuracy. The manifold can also be a cause of flow restrictions in high flow applications.



# General Description

# A

Introduction

You have purchased a SurePoint Sentinel NH3 blockage system for your equipment. This system will be controlled by the Sentinel ECU through your in-cab ISO display. Your anhydrous system will continue to function as usual with application rates being regulated by your existing rate controller. The Sentinel NH3 works independently, monitoring the row-to-row accuracy of your system and alerting the operator of blocked rows.

SurePoint currently supports Sentinel operating on the following displays: **John Deere** 2630 & 4640, **Ag Leader** InCommand 800 and 1200, **Case IH** Pro 700, **Trimble** Fm2050 and FMX1000. The use of Sentinel NH3 on any other display may result in diminished functionality.

A 2-pin Molex power and 12-pin Ampseal Power/CAN connector are required on your implement to connect the Sentinel ECU to the implement bus. While some equipment manufacturers already provide this connection, SurePoint offers harnessing to provide this connection on any implement. Ask your SurePoint representative what accommodations may be needed for your specific equipment.

## Basic Installation Steps

1. Install all Row sensors using the guidelines laid out in the Applicator Plumbing Requirements section on page 7.
2. Locate the 2-pin Molex power and 12-pin Ampseal POWER/CAN connectors (typically next to the rate controller) that the Sentinel ECU will be connected to and remove the terminator. If you can't identify these connectors, call SurePoint. Save the terminator for Step 5.
3. Mount the Sentinel ECU using the provided bracket in a location within 4 feet of the above connection.
4. Attach the ECU harness (208-06-3536Y2) to the Sentinel ECU and plug the other end of the harness into the above Molex/Ampseal POWER/CAN connection.
5. Use the previously removed terminator to terminate the POWER/CAN connection found on the ECU harness.
6. Mount the SurePoint NH3 Temperature Interface module (226-01-4210Y1) to the back of the ECU bracket used in step 2.
7. Plug the 4-pin Deutsch connector on the temperature interface module into the Flowmeter Bus 1.
8. Unplug the 3-pin Weather Pack dust plug that is connected to the temperature interface module and save.
9. Use a 3-pin Weather Pack extension cable (206-03-XXXX) to connect the temperature interface module to the row sensor mounted on Row 1.
10. Make sure all row sensors are daisy chained together, using 3-pin Weather Pack extension cables to get from NH3 manifold to NH3 manifold.
11. Install the 3-pin Weather Pack dust cover removed in step 8 and install it on the last row.

## SurePoint Sentinel NH3 Row Sensor Installation.



1. At the first NH3 manifold, disconnect the first NH3 line saving the hose clamp.
2. Use the included 3" piece of EVA tubing and connect it to the NH3 manifold hose barb.
3. Slide both hose clamps on the EVA tubing.
4. Push Row Sensor into the 3" piece of EVA tubing, **turning the sensor so the wires drop straight down** and tighten both hose clamps.
5. Re-connect NH3 line disconnected in step 1.
6. Continue back at step 1 until all Row sensors are installed.

## SurePoint Sentinel NH3 Applicator Plumbing Requirements.

1. All hose/ tubing from the manifolds must be equal in length with no splices or kinks.
2. All excess hose/ tubing from the manifolds must be fastened horizontally to the toolbar in coils no smaller than 18" in diameter.
3. If you have multiple manifolds, make sure they are all the same make and model. Make sure all the hose barbs are from the same manufacturer. NOT all hose barbs have the same inside diameter!
4. If you are not using all the ports on the NH3 manifold, make sure you evenly space out the plugs around the manifold.
5. Make sure all application knives are from the same manufacturer. Take time to inspect each knife to ensure all will flow equal. Make sure to pay attention to the NH3 application tube looking for kinks or bends that aren't normal. Also inspect for weld slag at the weld points.
6. Make sure that plumbing from the splitter to the manifold is all equal length. If doing more than two sections, make sure you use a high quality splitter to get even flow to each NH3 manifold.

# SurePoint Harness Layout for Sentinel NH3

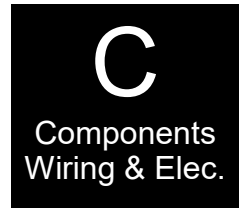

The SurePoint Temperature Interface module communicates with the Sentinel ECU through a proprietary communication network (CAN). The Sentinel ECU then, using the ISOBUS communication protocol, relays information through the tractor ISOBUS and generates the user interface on the in-cab display. A series of connections are required to form this communication network.

## Tractor Connection

Designed to integrate with any implement, in some cases, connecting the Sentinel starts at the tractor's ISOBUS connection. Power and information is relayed to the Sentinel ECU using a SurePoint Front ISO Extension which includes power and CAN bus connections. Already using the tractor ISOBUS? No Problem. SurePoint carries ISOBUS-Y harnesses to split the ISO connection at the tractor.

## Implement Height and Speed Input

Not used in all configurations, the implement height and speed input connections provide additional input options in situations that require advanced alarm control and an auxiliary speed source. These conditions generally exist only in hybrid systems, utilizing multi-branded components.

## Service Connections

The Terminating Resistor, Programming and RS232 connectors are for service only and should not be used.

## LiquiShift Connections

These two connectors are not used for Anhydrous Ammonia Application.

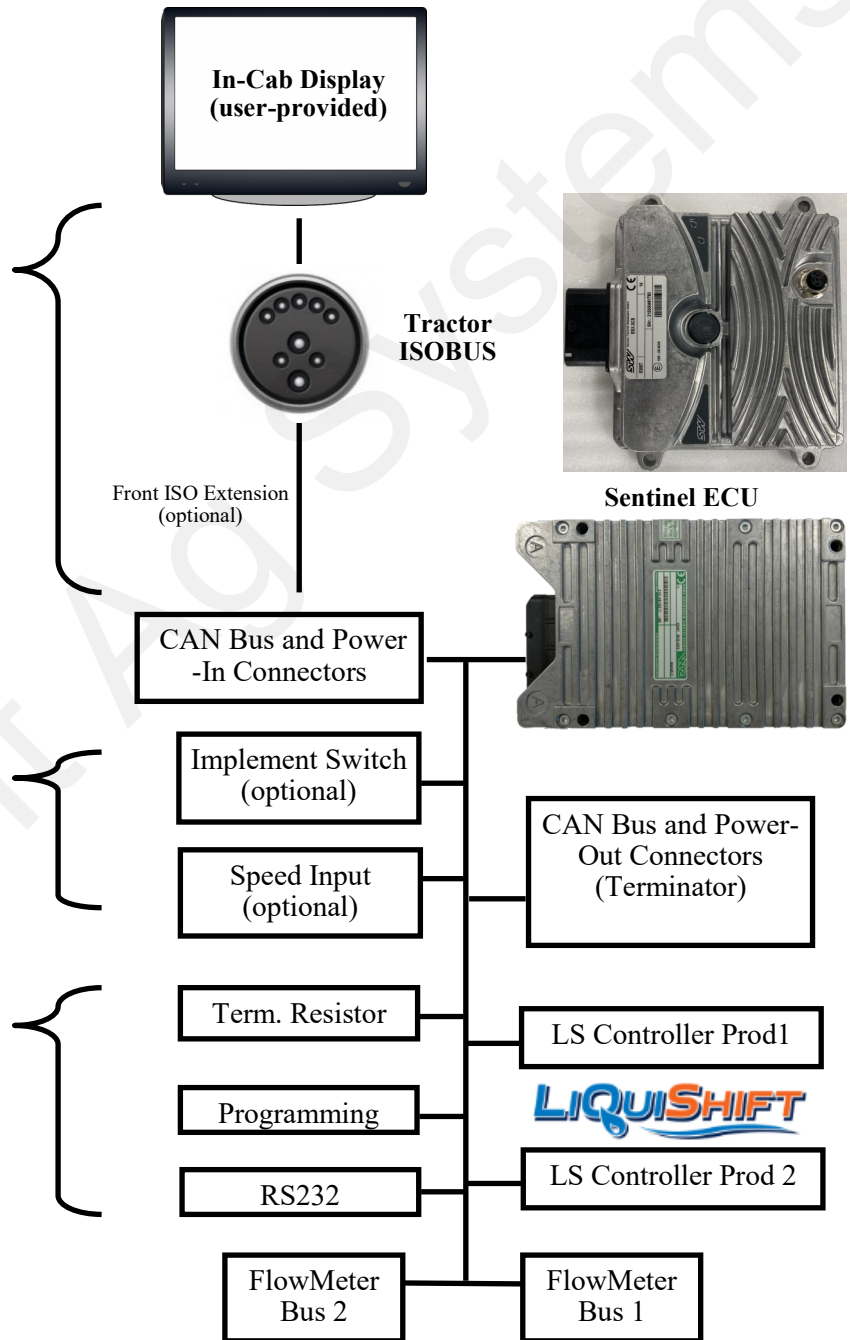

## Bus Connections

Two Flowmeter Bus connections are provided for use in several applications. For standard Sentinel NH3 use, connect the Temperature Interface Module to Flowmeter Bus 1.

# Component List

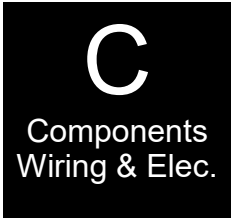

The major components of a Sentinel NH3 System are:

- Sentinel NH3 ECU
- Sentinel NH3 harness
- Temperature Interface Module
- Line Sensors (1 per row)
- 3-Pin Weather Pack extensions

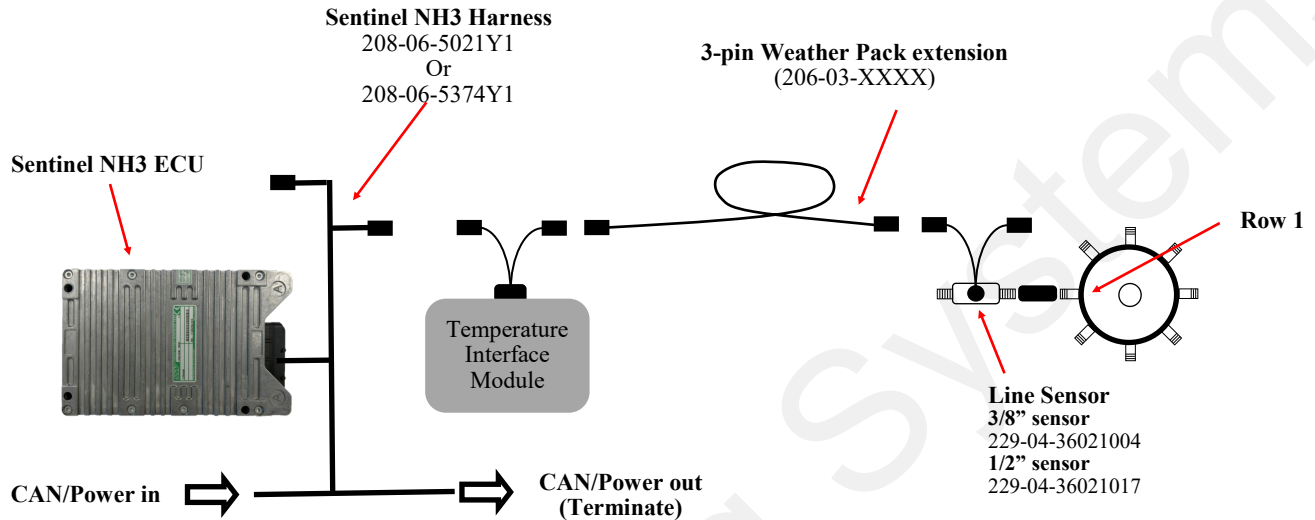

# Component Layout—Single NH3 manifold Layout

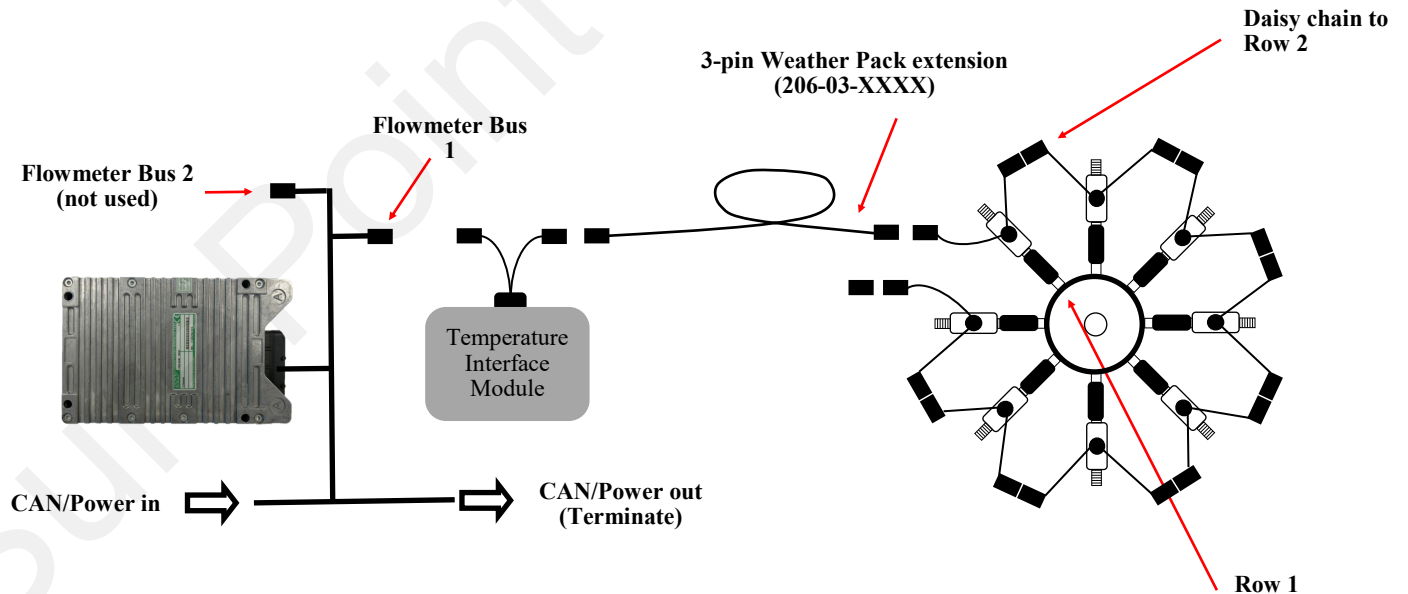

# Dual NH3 manifold Layout

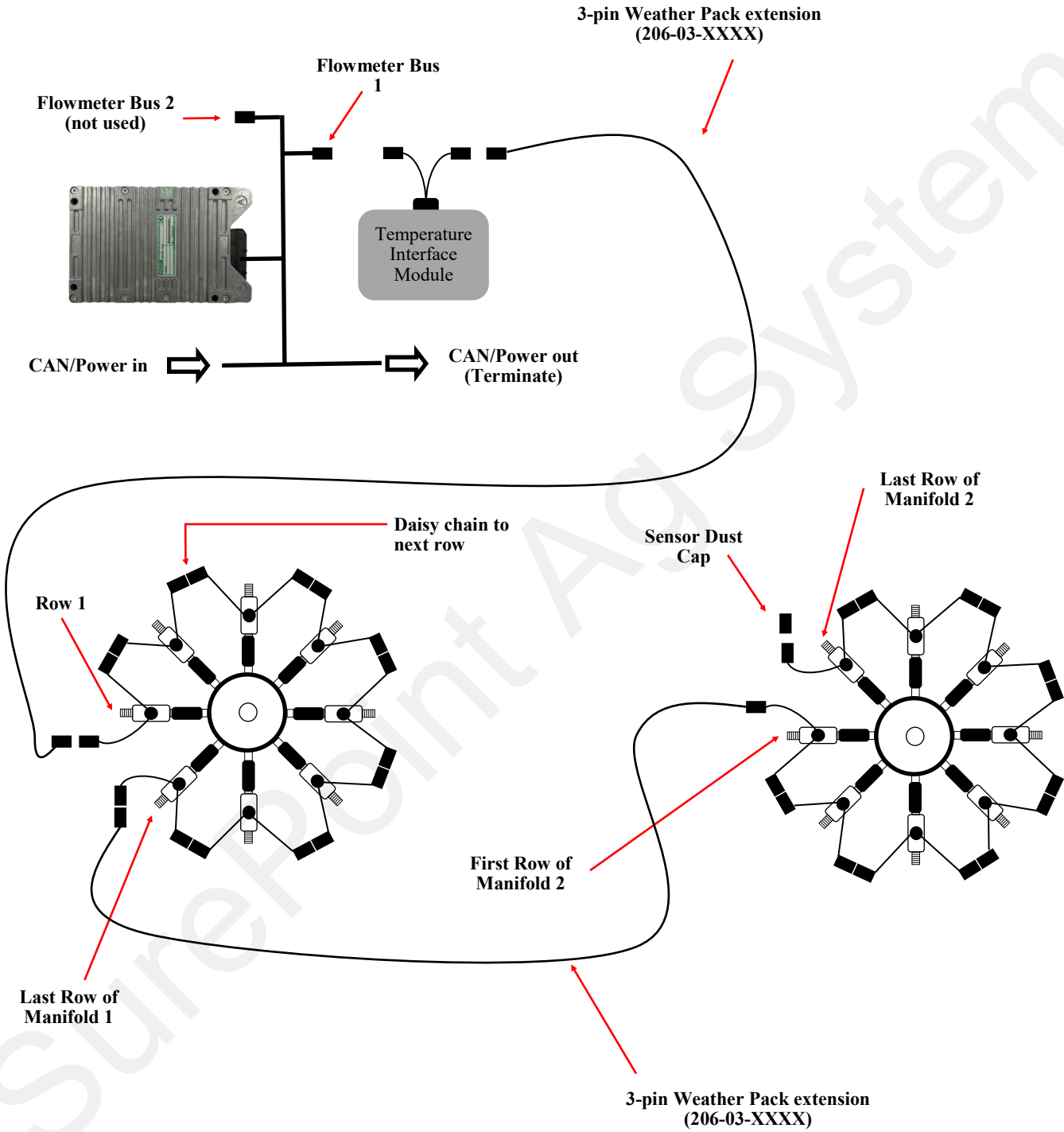

# Three NH3 manifold Layout

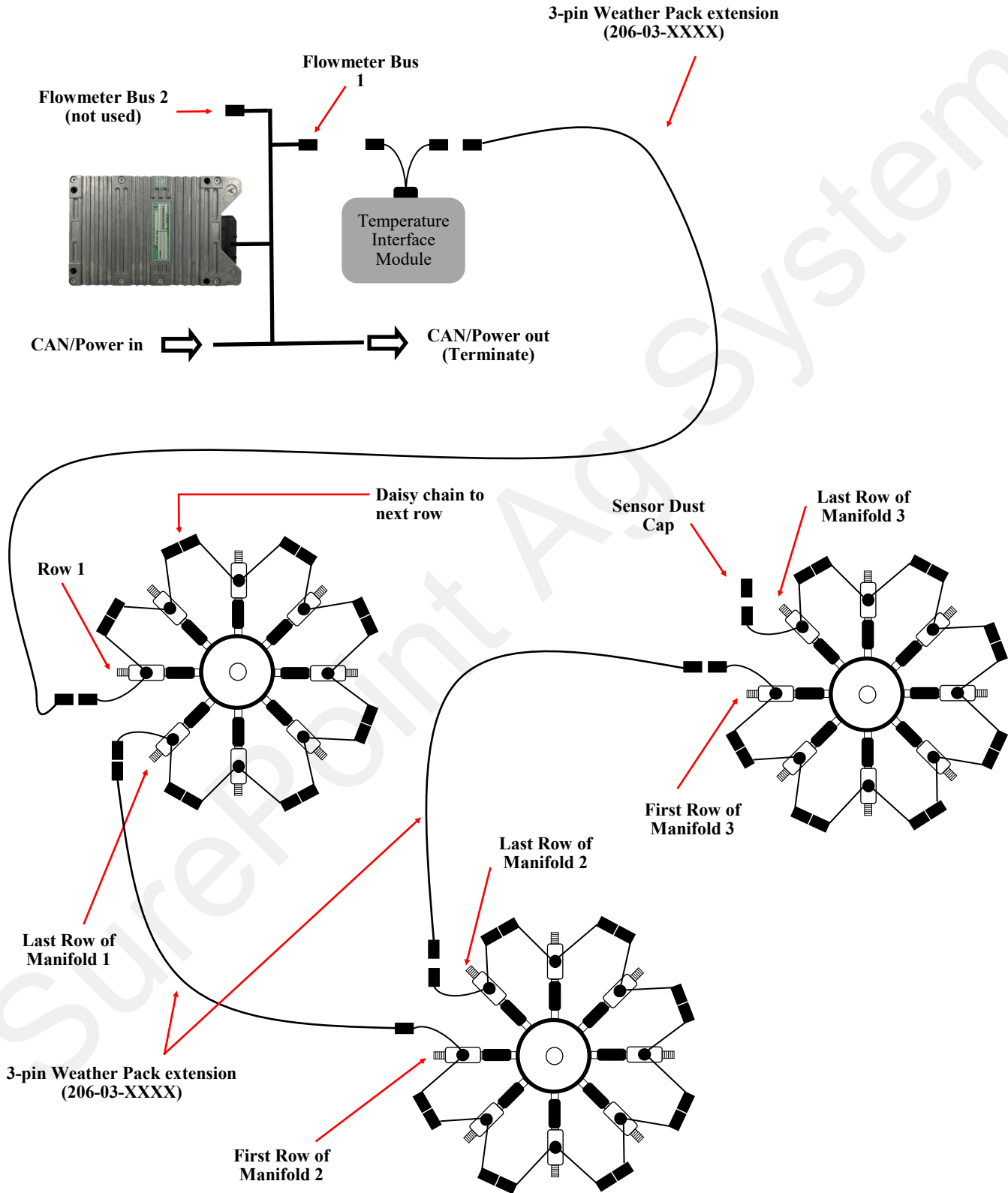

To install the Sentinel Temperature Interface Module Remove Can Bus Terminator from Flow Bus 1 on the Sentinel ECU Harness.

Install the 4-Pin Deutsch Y Adapter between the Flow Bus 1 Connector and the Temperature Interface Module.

Connect terminator to the other end of the Y adapter

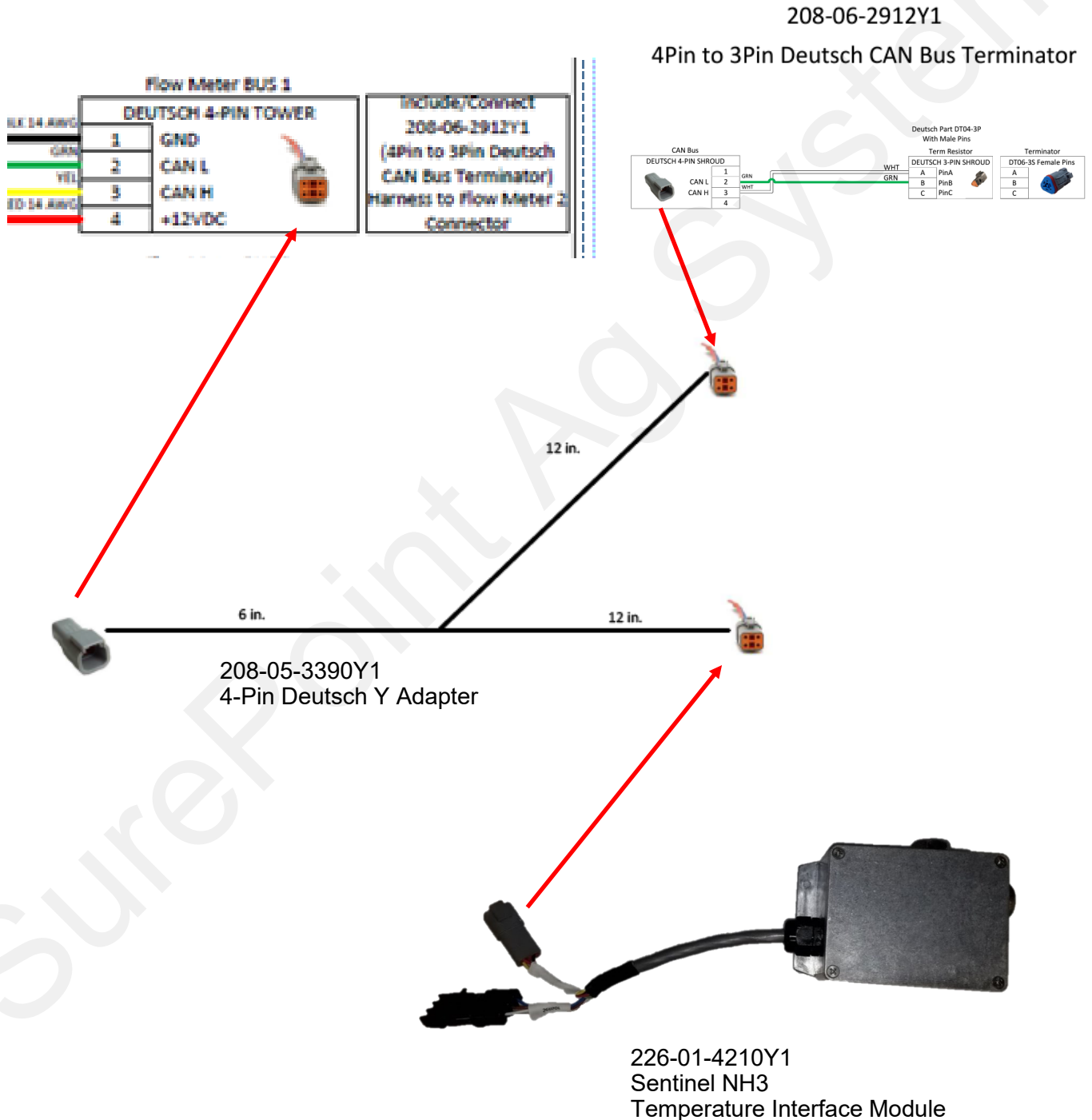

208-06-3536Y2

### 208-06-3536Y2 Sentinel ECU Harness

Tyco part number	Product name
1473244-1	81pos plug housing assembly, female, HQ5/JPT, COOP-A for KS1 (black)
368352-1	Retainer for 81pos HQ5 Plug
e.g. 964273-2	Female JPT contact (1.0 mm <sup>2</sup> ... 2.5 mm <sup>2</sup> )
e.g. 968221-1	Female HQ5 clean body contact (0.5 mm <sup>2</sup> ... 0.75 mm <sup>2</sup> , 5n)
962292-1	Sealing for JPT (ø = 2.7 mm ... 3.0 mm)
828922-1	Cavity plug for JPT (ø = 6.2 mm)
936054-1	Cavity plug for HQ5

Wire 18AWG  
unless otherwise  
specified

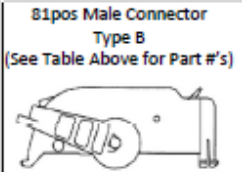

+12VDC Batt UE	6	RED 18 AWG
Ignition	25	RED 18 AWG
GND	2	BLK 14 AWG
<b>CAN 2 - ISOBUS</b>		
CAN L	64	GRN
CAN H	45	YEL
<b>CAN 1 - Programming</b>		
CAN L	26	GRN
CAN H	7	WHT
<b>CAN 3 - Flow Meter</b>		
CAN L	27	GRN
CAN H	8	YEL
<b>RS232</b>		
TXD	44	PPP
RxD	63	DRG
<b>CAN 4 - Future</b>		
CAN L	65	
CAN H	46	

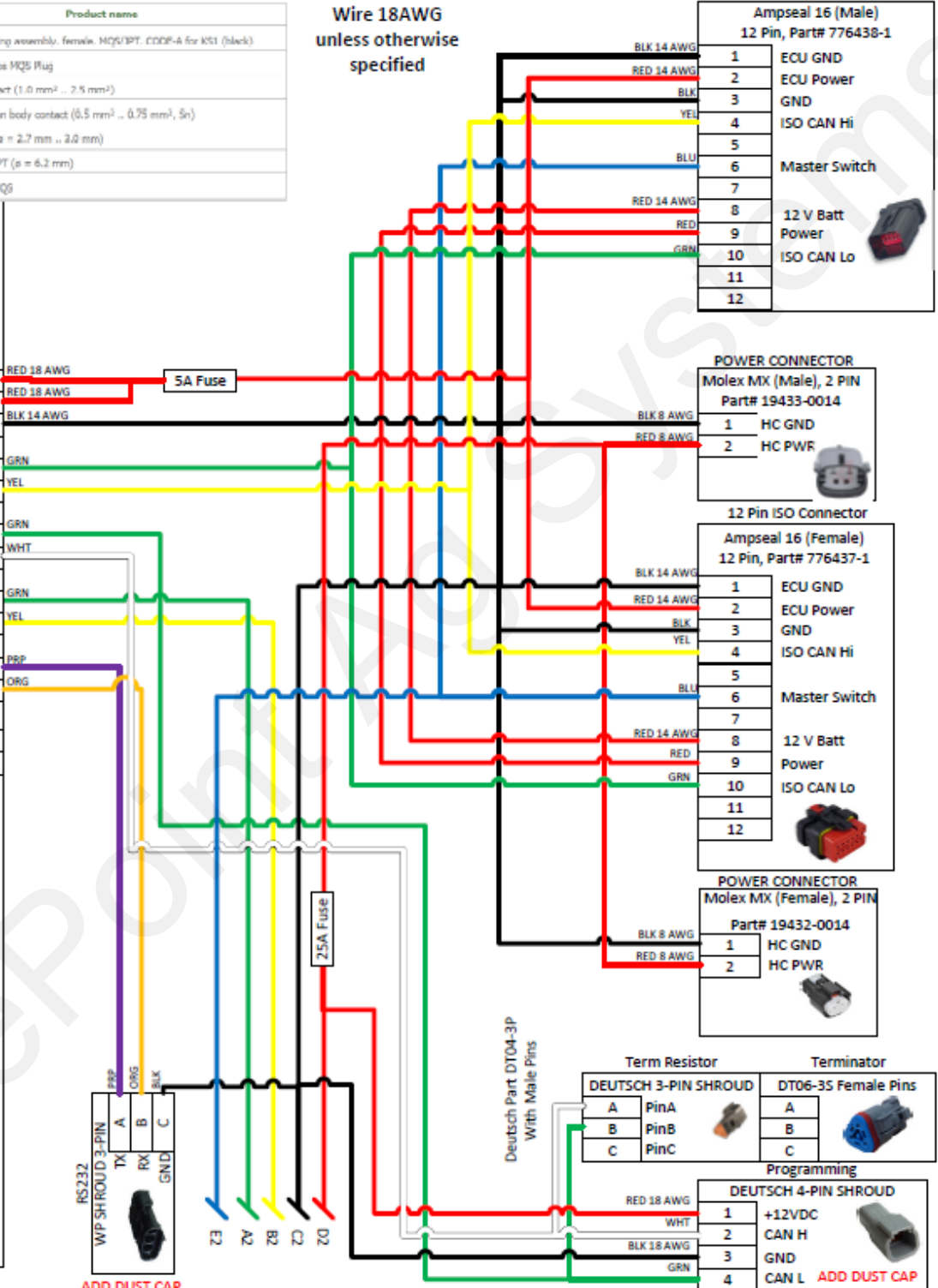

**Ampseal 16 (Male)  
12 Pin, Part# 776438-1**

1	ECU GND
2	ECU Power
3	GND
4	ISO CAN Hi
5	
6	Master Switch
7	
8	12 V Batt
9	Power
10	ISO CAN Lo
11	
12	

**POWER CONNECTOR  
Molex MX (Male), 2 PIN  
Part# 19433-0014**

1	HC GND
2	HC PWR

**12 Pin ISO Connector  
Ampseal 16 (Female)  
12 Pin, Part# 776437-1**

1	ECU GND
2	ECU Power
3	GND
4	ISO CAN Hi
5	
6	Master Switch
7	
8	12 V Batt
9	Power
10	ISO CAN Lo
11	
12	

**POWER CONNECTOR  
Molex MX (Female), 2 PIN  
Part# 19432-0014**

1	HC GND
2	HC PWR

Term Resistor		Terminator	
DEUTSCH 3-PIN SHROUD	DT06-3S Female Pins		
A PinA	A		
B PinB	B		
C PinC	C		

**Programming  
DEUTSCH 4-PIN SHROUD**

1	+12VDC
2	CAN H
3	GND
4	CAN L <b>ADD DUST CAP</b>

Connector Cont'd  
Next Page

ADD DUST CAP

	Part No:	208-06-3536Y2	Drawn By:	Albert E. Popp	
	Description:	208-06-3536Y2 Sentinel ECU Harness	Last Edit Date:	10/18/2017	Revision A-02
	Copyright 2016 SureFire Ag Systems, Reproduction or other use of drawing without express written permission from SureFire Ag Systems is forbidden			Page of Pages	1 of 3



208-06-3536Y2

208-06-3536Y2 Sentinel ECU Harness



81pos Male Connector  
Type B  
Cont'd Page 1

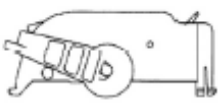

Wire 18AWG  
unless otherwise  
specified

**35V Inputs**

X_IN_01/Imp Swch	70	BLU
X_IN_02/Speed	12	BRN
X_IN_03/Left Spd	31	NA
X_IN_04/Right Spd	50	NA
X_IN_05/PWM1	69	NA
X_IN_06/PWM2	11	NA
X_IN_07/Master	30	NA
X_IN_08/P1_Flow	49	NA
X_IN_09/P2_Flow	68	NA
X_IN_10/P3_Flow	10	NA
X_IN_11/P4_Flow	29	NA
X_IN_12/Sect 10	48	NA

**12V Analog/Digital/4-20mA**

X_IN_13/Press1	67	PRP
X_IN_14/Press2	9	PRP
X_IN_15/Press3	28	NA
X_IN_16/Press4	74	NA
X_IN_17/AI5	16	NA
X_IN_18/AI6	35	NA
X_IN_19/AI7	54	NA
X_IN_20/AI8	73	NA

**Digital/Analog 0-5V/12V/  
Freq/ Pull-Up Only**

X_IN_21/Spare	57	YEL
X_IN_22/Spare	76	YEL
X_IN_23/Spare	18	NA
X_IN_24/Spare	37	NA
X_IN_25/Spare	41	NA
X_IN_26/Spare	60	NA
X_IN_27/Spare	79	NA
X_IN_28/Spare	21	NA

**High Current Outputs  
2.5Amps**

X_SYS_RELAY_04/ PWR	1	RED
X_OUT_21/LSA_P1	43	WHT/BLU
X_OUT_22/LSB_P1	62	PNK
X_OUT_23/LSA_P2	81	WHT/BLU
X_OUT_24/LSB_P2	23	PNK
X_OUT_25/PWM1	41	NA
X_OUT_25/PWM2	60	NA
X_OUT_25/PWM3	DO7	NA
X_OUT_25/PWM4	21	NA

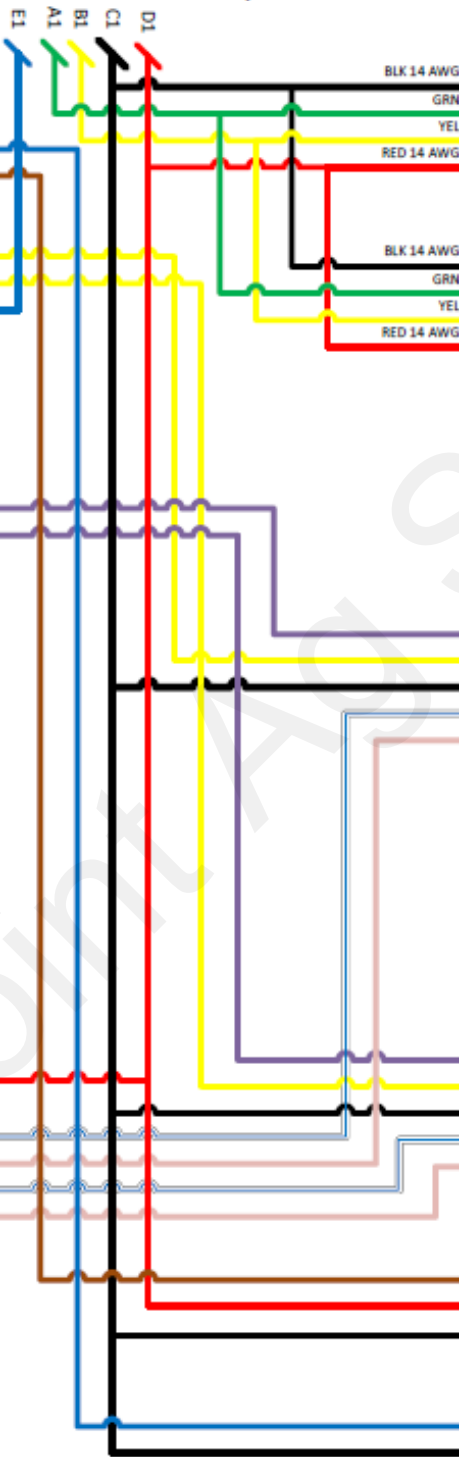

**Flow Meter BUS 1**

DEUTSCH 4-PIN TOWER	
1	GND
2	CAN L
3	CAN H
4	+12VDC

Include/Connect  
208-06-2912Y1  
(4Pin to 3Pin Deutsch  
CAN Bus Terminator)  
Harness to Flow Meter 2  
Connector

**Flow Meter BUS 2**

DEUTSCH 4-PIN TOWER	
1	GND
2	CAN L
3	CAN H
4	+12VDC

Include/Connect  
208-06-2912Y1  
(4Pin to 3Pin Deutsch  
CAN Bus Terminator)  
Harness to Flow Meter 2  
Connector

**LS Controller Prod1**

**8 Pin Deutsch Male**

1	+12VDC
2	GND
3	Pressure 1
4	PWM+
5	PWM-
6	Section 9
7	Section 10

ADD DUST CAP

**LS Controller Prod2**

**8 Pin Deutsch Male**

1	+12VDC
2	GND
3	Pressure 1
4	PWM+
5	PWM-
6	Section 9
7	Section 10

ADD DUST CAP

**Speed Input**

**150 MP Tower 3-PIN**

A	SIG
B	+12V
C	GND

**Implement Switch**

**WP TOWER 2-PIN**

A	SIG
B	GND



Part No:	208-06-3536Y2	Drawn By:	Albert E. Popp		
Description:	208-06-3536Y2 Sentinel ECU Harness	Last Edit Date:	10/18/2017	Revision	A-02
Copyright 2016 SureFire Ag Systems, Reproduction or other use of drawing without express written permission from SureFire Ag Systems is forbidden		Page of Pages	2 of 3		

208-06-3536Y2

208-06-3536Y2 Sentinel ECU Harness



Wire 18AWG  
unless otherwise  
specified

81pos Male Connector  
Type B  
Cont'd Page 1

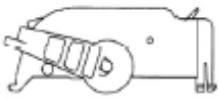

35V Inputs

X_IN_01/Imp Swch	70	BLU
X_IN_02/Speed	12	BRN
X_IN_03/Left Spd	31	NA
X_IN_04/Right Spd	50	NA
X_IN_05/PWM1	69	NA
X_IN_06/PWM2	11	NA
X_IN_07/Master	30	NA
X_IN_08/P1_Flow	49	NA
X_IN_09/P2_Flow	68	NA
X_IN_10/P3_Flow	10	NA
X_IN_11/P4_Flow	29	NA
X_IN_12/Sect 10	48	NA

12V Analog/Digital/4-20mA

X_IN_13/Press1	67	PRP
X_IN_14/Press2	9	PRP
X_IN_15/Press3	28	NA
X_IN_16/Press4	74	NA
X_IN_17/AI5	16	NA
X_IN_18/AI6	35	NA
X_IN_19/AI7	54	NA
X_IN_20/AI8	73	NA

Digital/Analog 0-5V/12V/  
Freq/ Pull-Up Only

X_IN_21/Spare	57	YEL
X_IN_22/Spare	76	YEL
X_IN_23/Spare	18	NA
X_IN_24/Spare	37	NA
X_IN_25/Spare	41	NA
X_IN_26/Spare	60	NA
X_IN_27/Spare	79	NA
X_IN_28/Spare	21	NA

High Current Outputs  
2.5Amps

X_SYS_RELAY_04/ PWR	1	RED
X_OUT_21/LSA_P1	43	WHT/BLU
X_OUT_22/LSB_P1	62	PNK
X_OUT_23/LSA_P2	81	WHT/BLU
X_OUT_24/LSB_P2	23	PNK
X_OUT_25/PWM1	41	NA
X_OUT_25/PWM2	60	NA
X_OUT_25/PWM3	DO7	NA
X_OUT_25/PWM4	21	NA

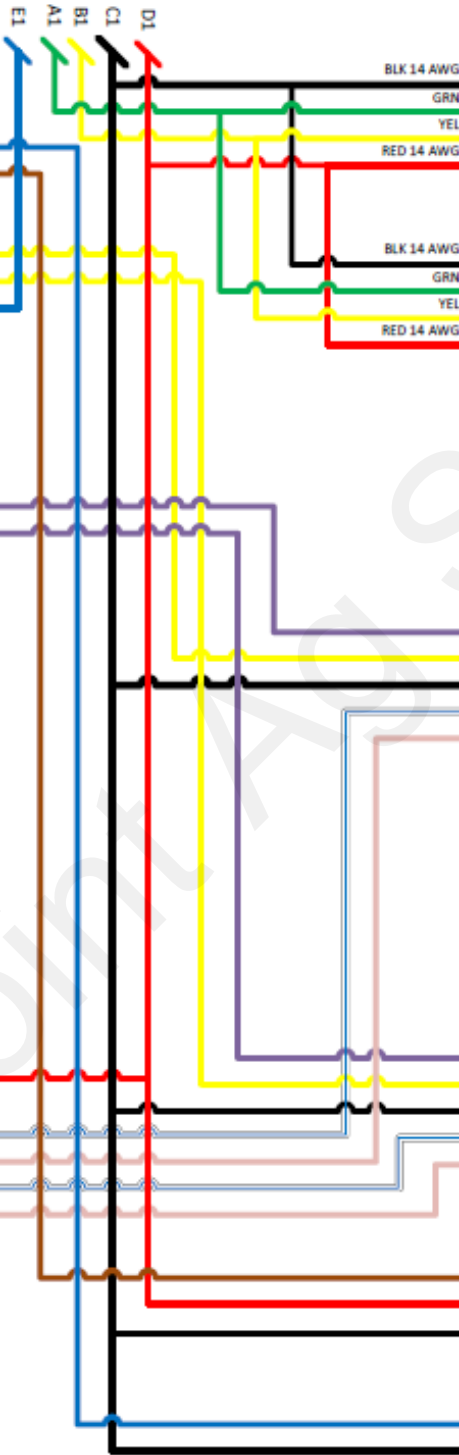

Flow Meter BUS 1

DEUTSCH 4-PIN TOWER	
1	GND
2	CAN L
3	CAN H
4	+12VDC

Include/Connect  
208-06-2912Y1  
(4Pin to 3Pin Deutsch  
CAN Bus Terminator)  
Harness to Flow Meter 2  
Connector

Flow Meter BUS 2

DEUTSCH 4-PIN TOWER	
1	GND
2	CAN L
3	CAN H
4	+12VDC

Include/Connect  
208-06-2912Y1  
(4Pin to 3Pin Deutsch  
CAN Bus Terminator)  
Harness to Flow Meter 2  
Connector

LS Controller Prod1

8 Pin Deutsch Male

1	+12VDC
2	GND
3	Pressure 1
4	PWM+
5	PWM-
6	Section 9
7	Section 10

ADD DUST CAP

LS Controller Prod2

8 Pin Deutsch Male

1	+12VDC
2	GND
3	Pressure 1
4	PWM+
5	PWM-
6	Section 9
7	Section 10

ADD DUST CAP

Speed Input

150 MP Tower 3-PIN

A	SIG
B	+12V
C	GND

Implement Switch

WP TOWER 2-PIN

A	SIG
B	GND



Part No:	208-06-3536Y2	Drawn By:	Albert E. Popp		
Description:	208-06-3536Y2 Sentinel ECU Harness	Last Edit Date:	10/18/2017	Revision	A-02
Copyright 2016 SureFire Ag Systems, Reproduction or other use of drawing without express written permission from SureFire Ag Systems is forbidden		Page of Pages	2 of 3		



208-06-3536Y2

208-06-3536Y2 Sentinel ECU Harness



81pos Male Connector  
Type B  
Cont'd Page 1

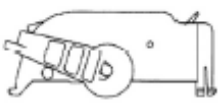

Wire 18AWG  
unless otherwise  
specified

**35V Inputs**

X_IN_01/Imp Swch	70	BLU
X_IN_02/Speed	12	BRN
X_IN_03/Left Spd	31	NA
X_IN_04/Right Spd	50	NA
X_IN_05/PWM1	69	NA
X_IN_06/PWM2	11	NA
X_IN_07/Master	30	NA
X_IN_08/P1_Flow	49	NA
X_IN_09/P2_Flow	68	NA
X_IN_10/P3_Flow	10	NA
X_IN_11/P4_Flow	29	NA
X_IN_12/Sect 10	48	NA

**12V Analog/Digital/4-20mA**

X_IN_13/Press1	67	PRP
X_IN_14/Press2	9	PRP
X_IN_15/Press3	28	NA
X_IN_16/Press4	74	NA
X_IN_17/AI5	16	NA
X_IN_18/AI6	35	NA
X_IN_19/AI7	54	NA
X_IN_20/AI8	73	NA

**Digital/Analog 0-5V/12V/  
Freq/ Pull-Up Only**

X_IN_21/Spare	57	YEL
X_IN_22/Spare	76	YEL
X_IN_23/Spare	18	NA
X_IN_24/Spare	37	NA
X_IN_25/Spare	41	NA
X_IN_26/Spare	60	NA
X_IN_27/Spare	79	NA
X_IN_28/Spare	21	NA

**High Current Outputs  
2.5Amps**

X_SYS_RELAY_04/ PWR	1	RED
X_OUT_21/LSA_P1	43	WHT/BLU
X_OUT_22/LSB_P1	62	PNK
X_OUT_23/LSA_P2	81	WHT/BLU
X_OUT_24/LSB_P2	23	PNK
X_OUT_25/PWM1	41	NA
X_OUT_25/PWM2	60	NA
X_OUT_25/PWM3	DO7	NA
X_OUT_25/PWM4	21	NA

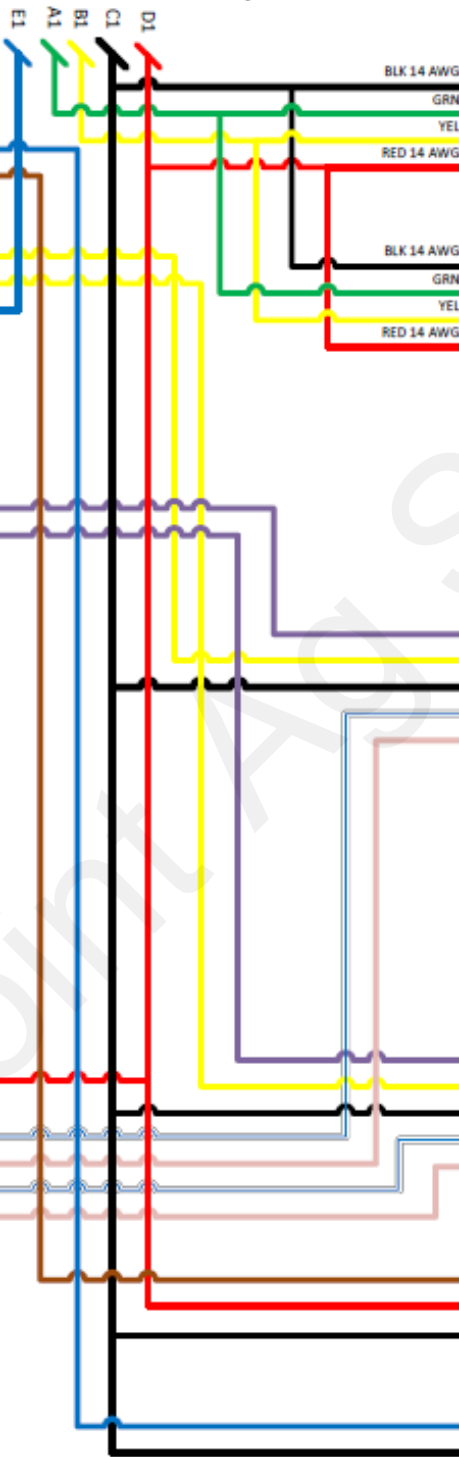

**Flow Meter BUS 1**

DEUTSCH 4-PIN TOWER	
1	GND
2	CAN L
3	CAN H
4	+12VDC

Include/Connect  
208-06-2912Y1  
(4Pin to 3Pin Deutsch  
CAN Bus Terminator)  
Harness to Flow Meter 2  
Connector

**Flow Meter BUS 2**

DEUTSCH 4-PIN TOWER	
1	GND
2	CAN L
3	CAN H
4	+12VDC

Include/Connect  
208-06-2912Y1  
(4Pin to 3Pin Deutsch  
CAN Bus Terminator)  
Harness to Flow Meter 2  
Connector

**LS Controller Prod1**

8 Pin Deutsch Male

1	+12VDC
2	GND
3	Pressure 1
4	PWM+
5	PWM-
6	Section 9
7	Section 10

ADD DUST CAP

**LS Controller Prod2**

8 Pin Deutsch Male

1	+12VDC
2	GND
3	Pressure 1
4	PWM+
5	PWM-
6	Section 9
7	Section 10

ADD DUST CAP

**Speed Input**

150 MP Tower 3-PIN

A	SIG
B	+12V
C	GND

**Implement Switch**

WP TOWER 2-PIN

A	SIG
B	GND



Part No:	208-06-3536Y2	Drawn By:	Albert E. Popp		
Description:	208-06-3536Y2 Sentinel ECU Harness	Last Edit Date:	10/18/2017	Revision	A-02
Copyright 2016 SureFire Ag Systems, Reproduction or other use of drawing without express written permission from SureFire Ag Systems is forbidden		Page of Pages	2 of 3		

214-00-3553Y1 Thru 214-00-3557Y1

Front Extension Harness – (9-Pin ISO Connector @ 3-Pin Master Switch to 12-Pin Ampseal 16 ISO and 2-Pin Molex Power)

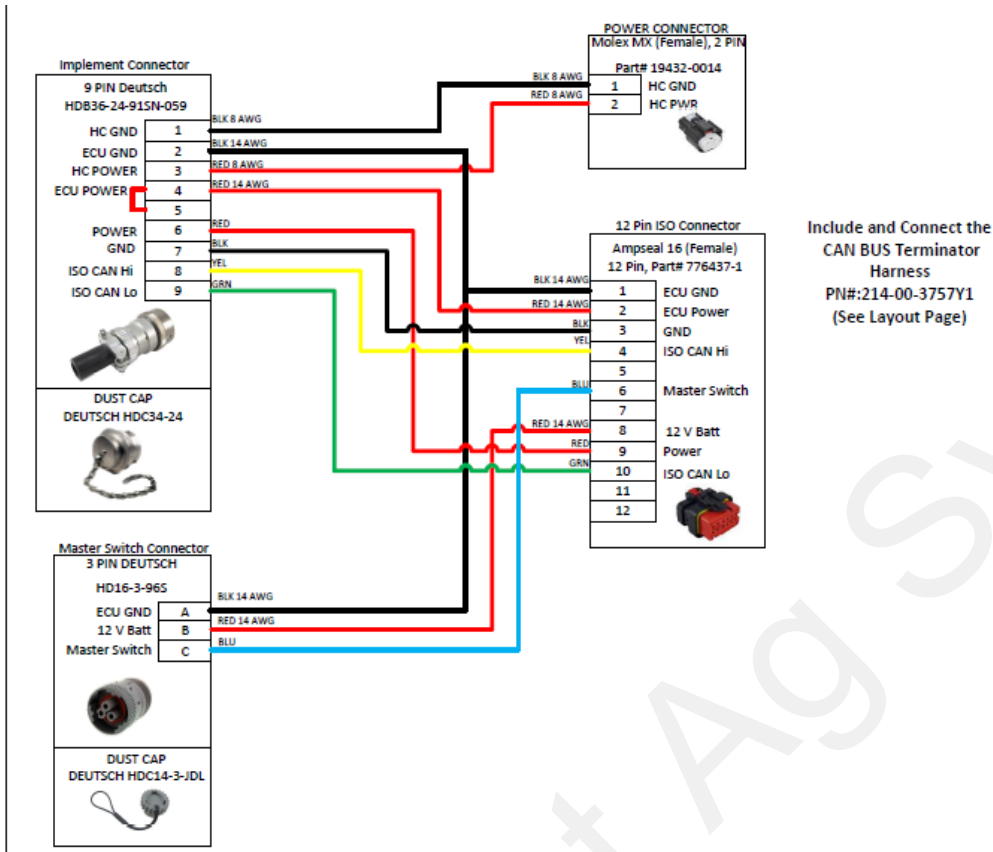
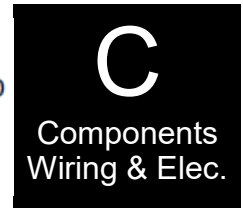

208-05-3390Y1

4-Pin Deutsch Y Adapter

Wire 18AWG unless otherwise specified

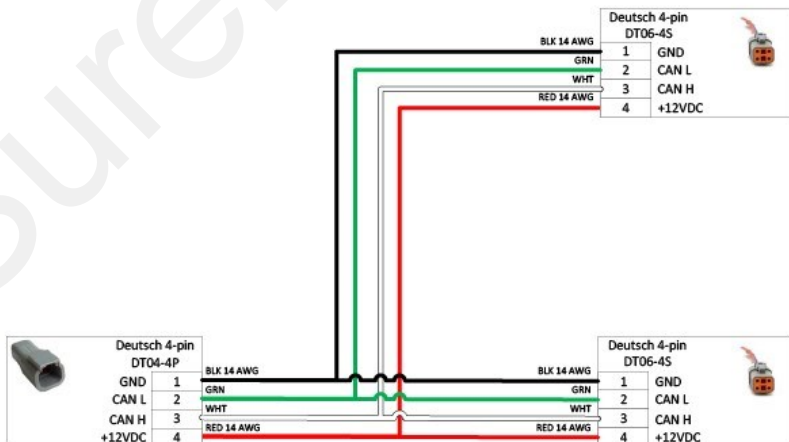

# Temperature Interface Module and Temperature Sensor

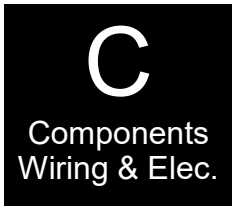

If the Temperature Interface Module is red on the NH3 module diagnostics screen, check voltages on the Flowmeter Bus connector to make sure the module is getting proper voltages.

Test voltage:  
 Pin 1 to 4 = 12v  
 Pin 1 to 2 = 1.5v  
 Pin 1 to 3 = 3.5v

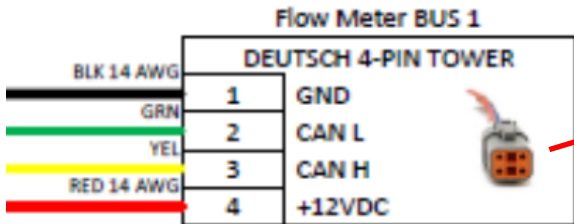

Temperature Interface Module



Temperature Sensor

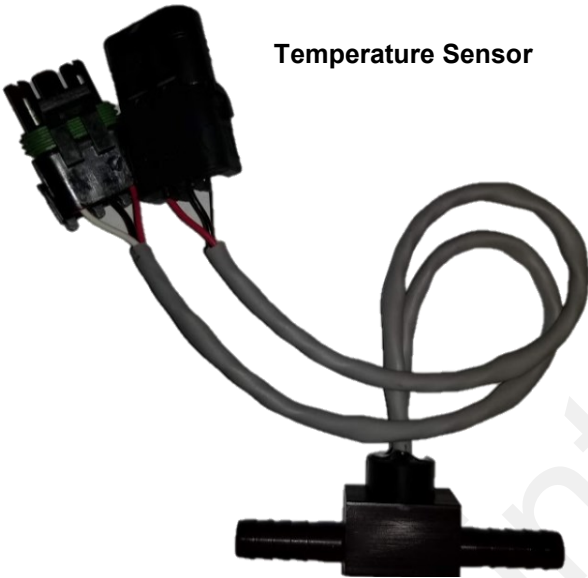

3-Pin WeatherPack connector on the sensors  
 A — Data  
 B — Ground  
 C — Handshake

Test voltage:  
 Pin A to B = 4-5v  
 Pin B to C = less than 1v

Line Sensor Connectors

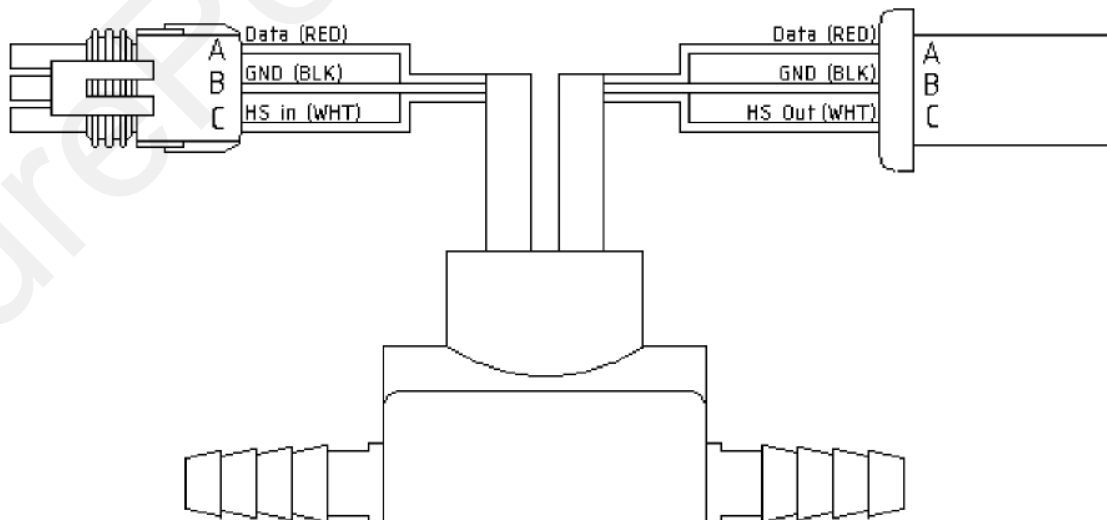

# Sentinel Setup and Configuration









## Set-up and Configuration

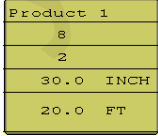
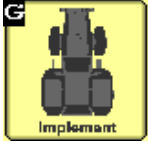

The following pages will guide you through the initial set-up and configuration of your Sentinel system. Below is an overview of the steps necessary to fully configure the system before operation. Each subsequent page outlines the page features as well as the sequence of buttons used to navigate to that page from the HOME screen.

## Basic Steps for Initial System Set-up

For detailed information on a step, go to the referenced page

REFERENCE Page #	STEP	
20	1. Press the <b>HOME</b> button	
21	2. Go to the Settings Page by touching the <b>SETTINGS</b> button	
21	3. On the Settings Page, specify the number of products being monitored (max. of 4)	
21	4. Configure each product by touching the <b>PRODUCT</b> button	
21	5. Select <b>Device Type: NH3 Temp</b>	
21	6. Set up each product with number of sections, rows, spacing, implement width and temperature tolerance. Start with tolerance at 15 degrees. Verify the Number of Rows in each Section. Press the <b>More</b> arrow if using half-rate or rate-and-a half on end rows. Press <b>BACK</b> arrow to go back.	
22	7. Set up the implement dimensions by touching the <b>IMPLEMENT</b> button. Then press <b>BACK</b> .	
23	8. Choose a speed source by selecting the <b>SPEED</b> button.	
23	9. Select system control options (task control, lift switch, etc.) under <b>HARDWARE</b> .	
	10. Touch the <b>NEXT</b> button.	
24	11. Customize alarms as desired.	
24	12. Click on <b>NH3 Module Diagnostics</b> .	
24	13. Ensure that all line sensors are plugged in and click <b>Readdress NH3 Sensors</b> .	
25	14. <b>Rate Setup</b> – Leave at <b>AUTO RATE</b> for NH3 monitoring.	

# Sentinel Setup and Configuration

## Home Screen Navigation



Real-time, row specific temperature data is displayed here.

Real-time, average temperature data for entire implement

The flow chart provides a quick visual reference of total system performance as well as individual row temperature.

The black bars represent the user-defined temperature tolerance above and below the current average temperature

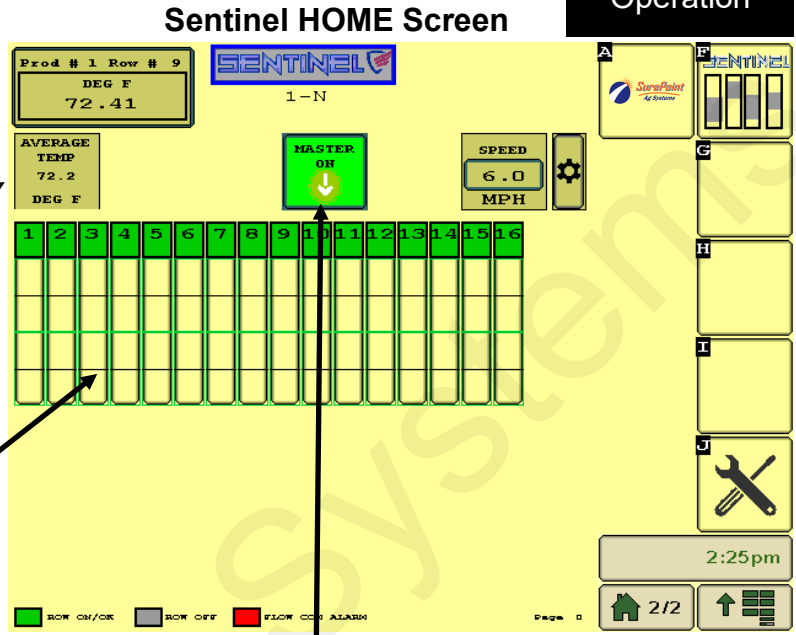

If equipped with an implement height switch that is plugged into the Sentinel ECU, this indicator shows the current implement height status.

### BUTTONS:



The HOME screen is accessible from any page by touching the Sentinel button.

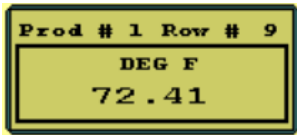

Touching the ROW DETAIL button will display individual row details including individual row temperature, module temperature, voltage, etc. (see page 24) To change the row that is being displayed in this button, touch the row on the flow chart. (see pg. 24)



Toggle between up to 4 product screens by touching the NEXT PRODUCT button. The Sentinel NH3 ECU has the ability to also monitor liquid products along with anhydrous ammonia.



The SETTINGS button will be used to access the system configuration pages and to change individual product alarm, tolerance, and rate settings. (see next page)



The MASTER ON/OFF button enables and disables the Sentinel NH3 system.

# Sentinel Setup and Configuration



## SETTINGS

Sentinel Settings Screen

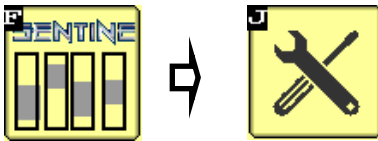

**INPUT** the number of products to be monitored through the Sentinel

Current Setup	
	Product 1
Mode	NH3RowMon
Rows	16
Sections	4
Spacing	30.00 Inch
Implement Width	40.0 FT

Versions 1.4.0 and later will have the **SET-UP GUIDE** button. Press the SETUP GUIDE and you will be navigated through the setup screens.

## PRODUCT SETUP



**INPUT:**

**Product Name-**

**Mode (Device)-** Choose **NH3 Row Monitor** (Temp on older Software)

**Sections** - Number of NH3 manifolds

**Total Rows**

**Spacing** - Row spacing in inches

**Start Row** - Sentinel row at which product starts. Leave at Row 1

**Tolerance** - Alarm setpoint above and below target rate measured in degrees Fahrenheit. Start with 8 degrees. This can be lowered as you get an idea of what typical temperatures are (this depends on the manifolds).

**Num Rows** - Number of rows in each section

Press **More** arrow.

Product Setup Screen



# Sentinel Setup and Configuration



## PRODUCT SETUP (cont.)

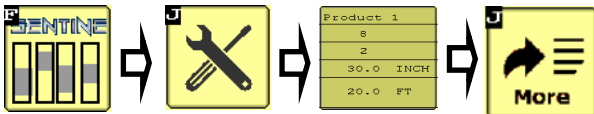

Product Setup Screen (pg 2)

**LiquiShift Enbl** - Check this box if your system includes a SurePoint LiquiShift that will be controlled through the Sentinel. **(Liquid Only)**

**Rate for Outside Rows:** Indicate here if using half rate (x 0.5) or rate and a half (x 1.5) on the outside rows.

### Special settings for interplant planters

The following settings can be activated to monitor only the rows that are being used

**Split Row Md** - check this box when interplant rows are disabled.

**Disable ODD Rows** - press to disable the Sentinel for all odd-numbered rows

**Disable Even Rows** - press to disable the Sentinel for all even-numbered rows

**Enable All Rows** - press to read all rows

BACK arrow (twice)

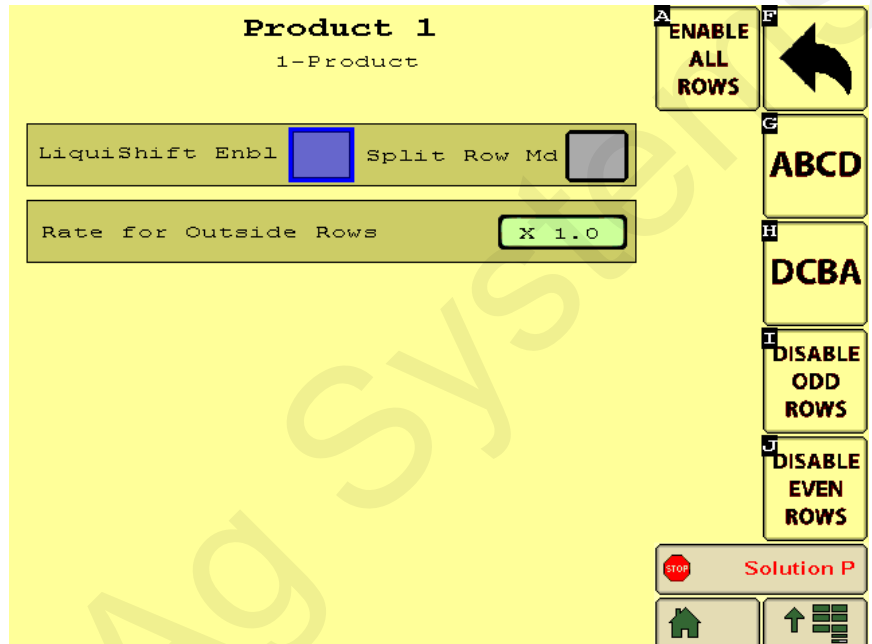

## Implement SETUP



Implement Setup Screen

The implement setup dimensions are used when Task Control is enabled. This allows the display to know the position of the liquid boom to turn on/off sections to match the liquid. Sentinel then automatically disables the alarms for sections as flow to those sections is turned off.

A = distance from GPS Antenna to Hitch

B = implement offset (Left or Right)

C = distance from hitch to application point

Section Timing not needed for NH3.

BACK arrow.

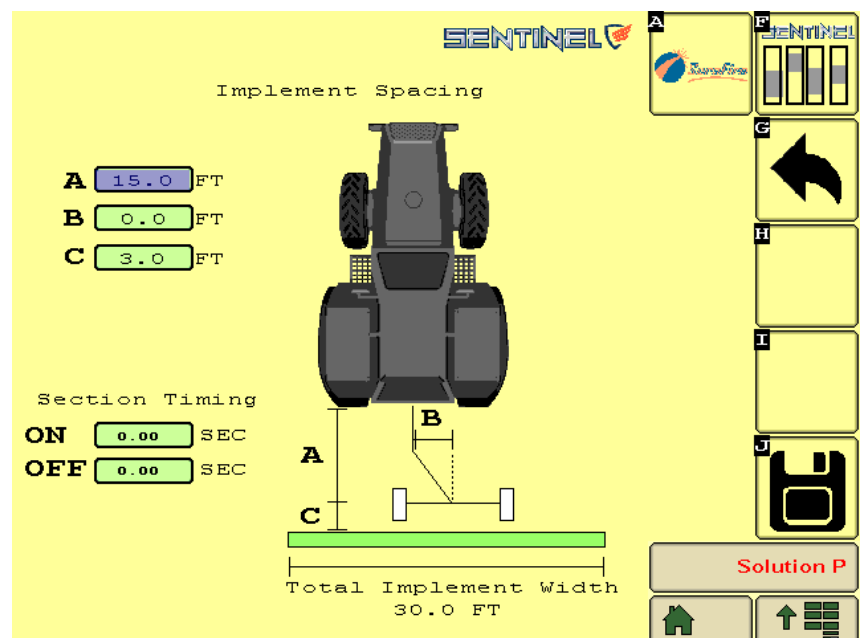

# Sentinel Setup and Configuration



## Speed Input and Calibration



### Speed Setup Screen

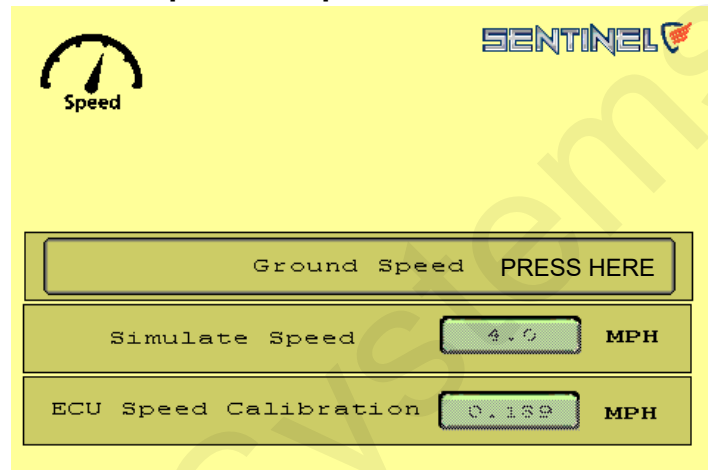

#### Select Speed Source:

**Ground Speed (default)** - GPS speed or speed posted by the tractor ECU

**Wheel Speed** - speed of the tractor wheels. Slip is not accounted for.

**Machine Selected Speed** - user-defined speed posted by tractor ECU

**Simulated Speed** - to perform stationary flow tests, a simulated speed must be entered

**ECU Input Speed** - alternate speed input on Sentinel ECU harness can be plugged into a wheel-speed sensor or GPS speed receiver.

**Speed Calibration** - used to calibrate the ECU input speed source.

NOTE: If the selected speed source does not cause Sentinel to display speed, choose another source until speed is displayed.

## Hardware



#### Select Hardware Options:

**Master Switch**-- Check only if there is a dedicated Master Switch plugged into the Sentinel. (Not typical)

**Lift Switch** - check ONLY if the Sentinel has a dedicated lift switch plugged into the Sentinel harnessing. The switch used by your rate controller IS NOT used by Sentinel. If using a dedicated lift switch, the implement position indicator will appear on the HOME screen.

**Pump Speed** - for liquid products.

**Task Control** - permits Sentinel to use available task control information on the bus regarding section control. ENABLE TASK CONTROL if Task Control is available from your display.

**IntelliSection** - enabling IntelliSection allows the Sentinel to determine when sections are turned off by looking at temperature across the entire section. When the average temperature across the section raises, alarms for those rows are disabled. **Check this box if not using Task Control. If using IntelliSection, you should also use a Lift Switch on the Sentinel.**

Go BACK.

### Hardware Setup Screen

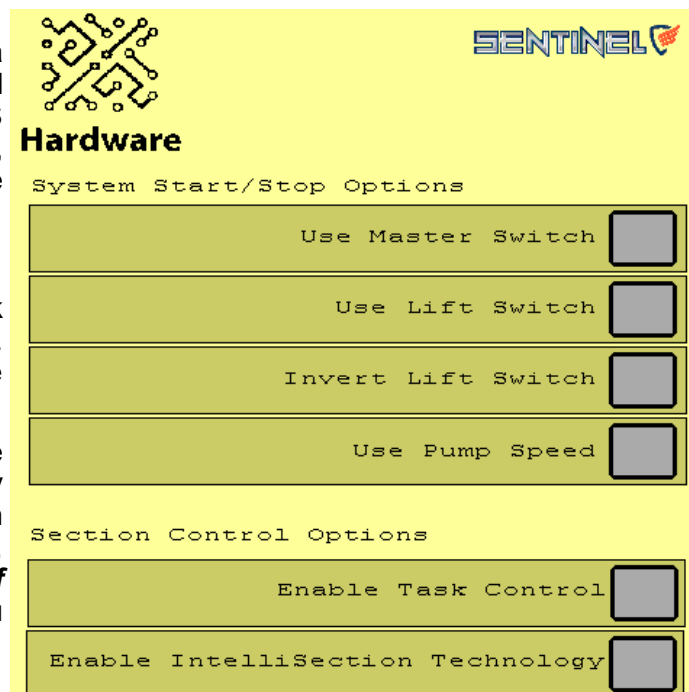

# Sentinel Setup and Configuration

D

Setup & Operation

## Customizing Alarms, etc



This screen allows the user to change how row information is displayed on the HOME screen. When checked, the **Auto Scan** feature will scan through the rows and/or product pages on the HOME screen.

**Auto Hide Alarms** sets how long full-page alarms are displayed. (see pg. 24)

**Alarm Time** is how long a row must be outside of the specified tolerance before the alarm sounds.

**NH3 Module Diagnostics** - NH3 module diagnostics is addressed below.

**Store Object Pool** - Stores the current layout

**Delete Object Pool** - Deletes the current layout and forces the monitor to regenerate the display

**Next VT** - press to push Sentinel to another virtual terminal.

### Customizing Alarms Screen

Auto SCAN Pages	<input type="checkbox"/>	10.0	SEC
Auto SCAN Rows	<input checked="" type="checkbox"/>	5.0	SEC
Auto Hide Alarms	<input type="checkbox"/>	5.0	SEC
Disable Alarms	<input type="checkbox"/>		
Alarm Time		5	SEC
Re Alarm Interval	<input type="checkbox"/>	50	SEC
Bus Update Interval		500	MSEC
			NH3 Module Diagnostics
Store Object Pool	Delete Object Pool	Next VT	

## Addressing Sentinel Flow Modules



### NH3 Module Diagnostics

To address the Sentinel Line Sensors, start by having all the sensors plugged in. From this screen, push **Readdress NH3 Sensors** button. This turns off all the sensors and turns them back on. Sensor 2 does not turn on unless, Sensor 1 has turned on first because of how the sensors daisy chain together.

### NH3 Module Diagnostics Screen

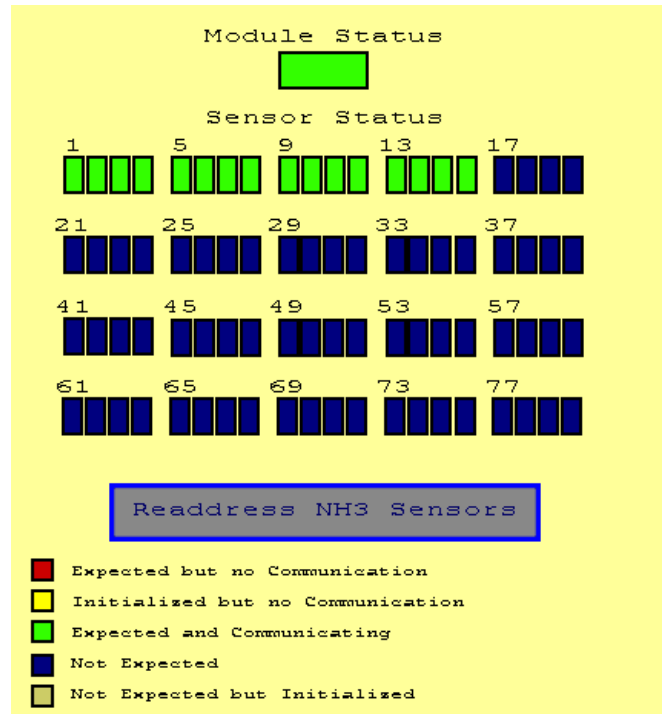

# Sentinel Setup and Configuration



## Rate Setup



For NH3 monitoring, leave the Rate set at *AUTO RATE*.

## Rate Setup Screen

# Sentinel Operation



Once the Sentinel has been set up in the display, little is required of the user to operate the Sentinel. The system is designed to run in the background and only alert you if there is a problem. As previously mentioned, the HOME screen yields a quick snapshot of row-to-row comparisons while the row detail report gives more specific information about each row.

From the HOME screen, when the temperature for a row or rows goes outside the set tolerance, the row will display red in the bar chart.

Anhydrous at the tank is under pressure and at a higher temperature than at the bottom of the knife. Anhydrous is colder at the bottom of the knife because the pressure is lower where the anhydrous is exiting the plumbing system. If the bar temporarily goes down (lower temperature than average) and then gradually gets warmer than the average, typically the plug will be before the sensor. This happens because the remaining anhydrous in the line is no longer under pressure from the manifold and the line cools because of the boiling off of the anhydrous. The sensor will eventually warm up because of the extended period of no flow.

If the bar goes up, typically the plug would be after the sensor. NH3 would be under pressure because of the plugged knife and unable to bleed off. This higher pressure and no flow would cause the sensor to be warmer.

A broken hose/ knife can also cause the bar to go down. A broken NH3 hose can cause an overflow of anhydrous to go to that broken line, making that line sensor colder than the others.

*Watch this Home Screen to get an idea of where the Tolerance should be set. If the Tolerance is too low, you will get false alarms. If it is too high, it will take longer to alarm if there is a problem. You may be able to set the Tolerance to 10 or less.*

If a row falls outside the set tolerance, a full page alarm is displayed. The length of time from when the row shows a problem to when this alarm is displayed is determined by the **ALARM TIME** previously set. This page will close automatically based on the **AUTO HIDE** time previously set.

## Sentinel HOME Screen

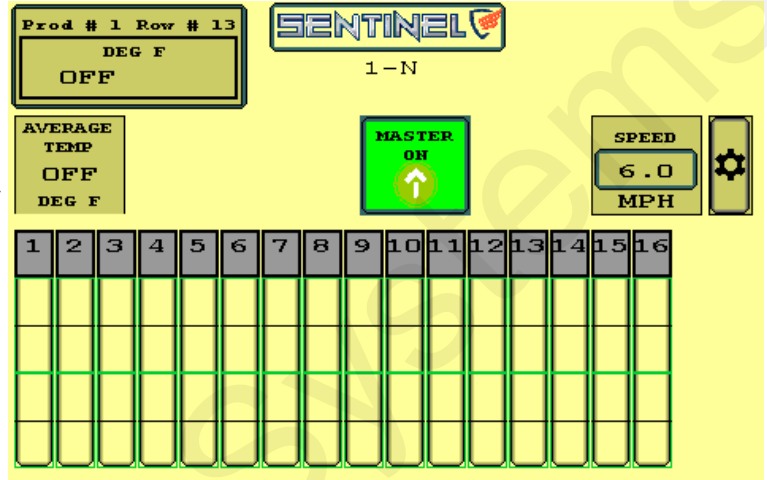

## ALARM Screen

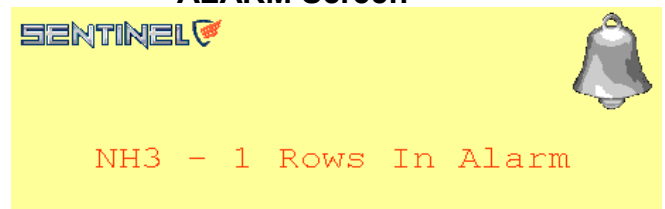

## Row Detail Button



From the HOME screen, touching the row detail button will display the row detail page. The user can toggle through the rows by touching the < > buttons. The user can also pause the **Auto Scrolling** feature pressing the **Pause Scan** button.

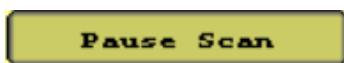

## Row Detail Page

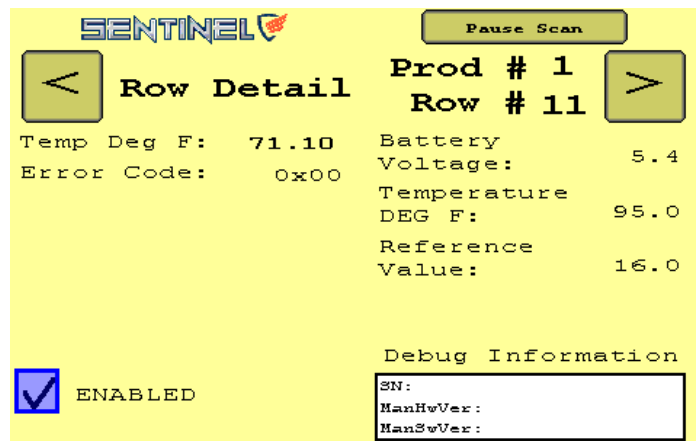



# Sentinel NH3 Troubleshooting

# E

Trouble-Shooting

## Sentinel doesn't show up on my display

1. Verify that the Sentinel ECU has power - 2 green lights should be illuminated on the ECU.
  - A. Using a voltage tester, check voltage on the ECU harness as identified on pages 13-17.
2. Check connections:
  - A. Tractor ISO plug
  - B. CAN and power connections leading to the ECU harness

## Sentinel NH3 Line Sensor(s) will not address

1. Make sure that the Temperature Interface Module is plugged into the Flowmeter Bus connector on Sentinel harness.
2. Make sure Line Sensor 1 is plugged into the Temperature Interface Module like on the Component Layout on Page 9.
3. Make sure all Line Sensors are plugged in correct order.
4. Check the **NH3 Module Diagnostics** screen to confirm all Line Sensors and Temperature Interface module are green. Press **READDRESS NH3 SENSORS** to restart all the sensors and readdress them.

## All Sentinel NH3 Line Sensors are red on NH3 Module Diagnostics page.

1. On the top of the NH3 Module diagnostics screen, is the module status green? If yes, move on to step 2. If no, skip to step 3.
2. Unplug all line sensors except Sensor 1. Push **Readdress NH3 sensors** button and see if first sensor status turns green. If the sensor status turns green, then continue to plug one sensor at a time, pushing the **Readdress NH3 sensor** button between each time you plug in a sensor. If you come across a sensor that makes all the sensors turn red, unplug it and skip it on the daisy chain of sensors and see if the sensor after the bad sensor will turn green. If the next sensor turns green, then call SurePoint for sensor replacement.
3. If the module status is red, refer to page 16 wiring diagram and test voltages.

## Sentinel shows no flow and rows are grey

1. Make sure the **MASTER** button on the **HOME** screen displays **MASTER ON**. If not, touch the button to cycle it.
2. Is Sentinel disabling the rows?
  - A. Go to the **HARDWARE** page. (see pg. 23) If **USE LIFT SWITCH** box is checked, and a dedicated lift switch is not installed, the Sentinel is disabling flow on all rows because it thinks the implement is up. Uncheck the **USE LIFT SWITCH** box. If a dedicated lift switch is installed and plugged into the Sentinel ECU harness, the switch may need adjusted to correctly show the implement status. If a lift switch is used that is normally closed, the **INVERT LIFT SWITCH** box needs to be checked.
3. Are you performing a stationary test? If so, a simulated speed must be entered. (see pg. 23)
4. Is a speed being displayed on the Sentinel **HOME** screen when moving?
  - A. If not, change the speed source (see pg. 23)

# Sentinel NH3 Troubleshooting

# E

Trouble-Shooting

## Individual rows read high or low

1. Check row plumbing
  - A. Look for pinched or kinked lines to the row
  - B. Look for plugged knives
  - C. Make sure all row plumbing is the same length
  - D. Check to make sure knives are all from the same manufacturer
  - E. Flip the outlet plumbing for 2 rows and determine if the problem follows the row
    - If the low/high reading stays with the same row on the Sentinel, inspect sensor and before for plugging.
    - If the low/high reading follows the row plumbing, look after the sensor for issues
5. If the row continues to read high/low, the sensor may be faulty.

## Sentinel alarms too often

Often times during initial start-up the Sentinel alarms can seem excessive as Sentinel highlights the row-to-row inaccuracies in the system. Small things like tubing lengths and line splices can make big differences in row to row accuracy. To start out, a user may consider increasing the **TOLERANCE** up to 15 degrees until these issues are resolved. Here are some other adjustments that can be made:

1. Decrease the length of time that full-page alarms display by changing the **AUTO HIDE ALARMS** setting.
2. Increase the time before a row alarms by increasing the **ALARM TIME** setting.
3. Is Sentinel alarming when the implement is up or when turning around?
  - Consider disabling alarms with the use of a lift switch
4. Go to the **ROW DETAILS** and disable the problematic row
5. Disable all alarms by checking the **DISABLE ALARMS** box

## Sentinel Doesn't display speed

1. Change the speed source as reference on page 23. Toggle through the speed sources until speed displays.
2. If none of the speed sources are working, a communication problem with the tractor may exist. Consult your tractor dealer or add a GPS speed receiver found in the Accessories section of this manual.



# Sentinel Care and Maintenance

F

Care &  
Maintenance

## Cleaning

Under no circumstance should the Sentinel modules or ECU be cleaned with a pressure washer. While the flow modules and ECU are sealed, the intense pressure generated by pressure washers may penetrate the seals and cause irreversible damage.



## Winterization

If injecting a nitrogen stabilizer, SurePoint recommends flushing your system by running at least one tank of NH<sub>3</sub> without the nitrogen stabilizer to clean the system out.

## Pre-season Service

*(A little time spent here may prevent some downtime when you want to be rolling.)*

1. Visually check entire system (hoses, fittings, harnesses, etc.) for any signs of wear or trouble.
2. On the display, recheck all setup screens (see Section D) to verify correct setup.
3. Tighten all clamps. Loose clamps may be evident by leaks on the output side of the system.

# Sentinel NH3 Accessories

G

Accessories

## Mounting Brackets

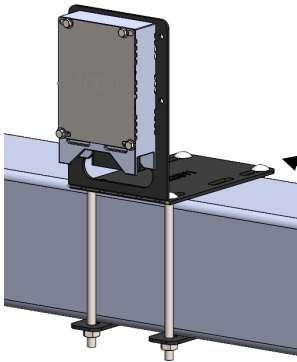

### Sentinel Mounting Brackets

Part Number	Description
515-100950	Sentinel ECU Mounting Bracket Kit

## Front ISO Extension Harnesses

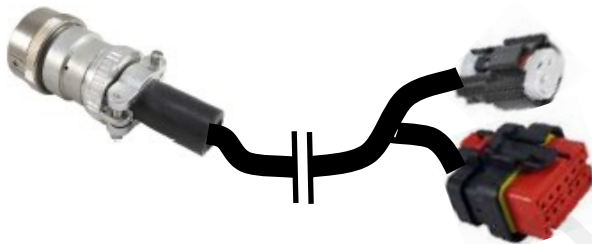

Part Number	Description
214-00-3553Y1	10 FT. Front ISO Extension Harness
214-00-3554Y1	20 FT. Front ISO Extension Harness
214-00-3555Y1	30 FT. Front ISO Extension Harness
214-00-3556Y1	40 FT. Front ISO Extension Harness
214-00-3557Y1	50 FT. Front ISO Extension Harness

## Implement Height Switches



Part Number	Description
501-100530	Magnetic Finger Type Height Switch
501-1005	Magnetic Mercury Switch

## GPS Speed Receiver



Part Number	Description
203-01-01410	Astro II with 3-pin MP 150 Shroud

# Sentinel NH3 Accessories

## 3-Pin Weather Pack Extensions

G

Accessories

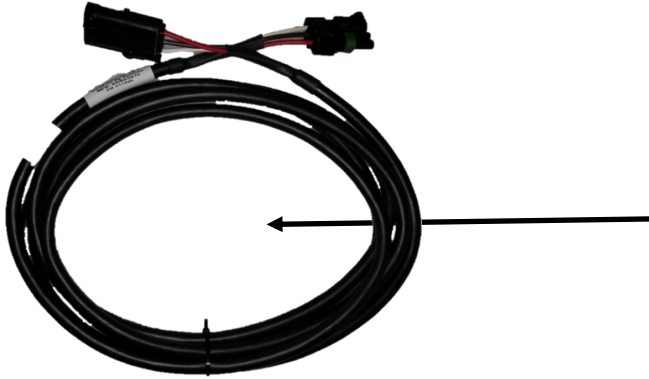

Part Number	Description
206-03-10450	3-pin 5' WP Extension Cable
206-03-10449	3-pin 10' WP Extension Cable
206-03-10876	3-pin 15' WP Extension Cable
206-03-10829	3-pin 20' WP Extension Cable
206-03-11462	3-pin 25' WP Extension Cable
206-03-11530	3-pin 30' WP Extension Cable
206-03-11535	3-pin 35' WP Extension Cable
206-03-11540	3-pin 40' WP Extension Cable
206-03-11545	3-pin 45' WP Extension Cable
206-03-11550	3-pin 50' WP Extension Cable

## Dust Cap



Part Number	Description
374-3687Y1	3-Pin WP Dust Cap

# SENTINEL $NH_3$

ANHYDROUS ROW MONITOR



***SurePoint***  
***Ag Systems***

SurePoint Ag Systems  
9904 Hwy 25  
Atwood, KS 67730  
[www.surepointag.com](http://www.surepointag.com)

